

amazon basics

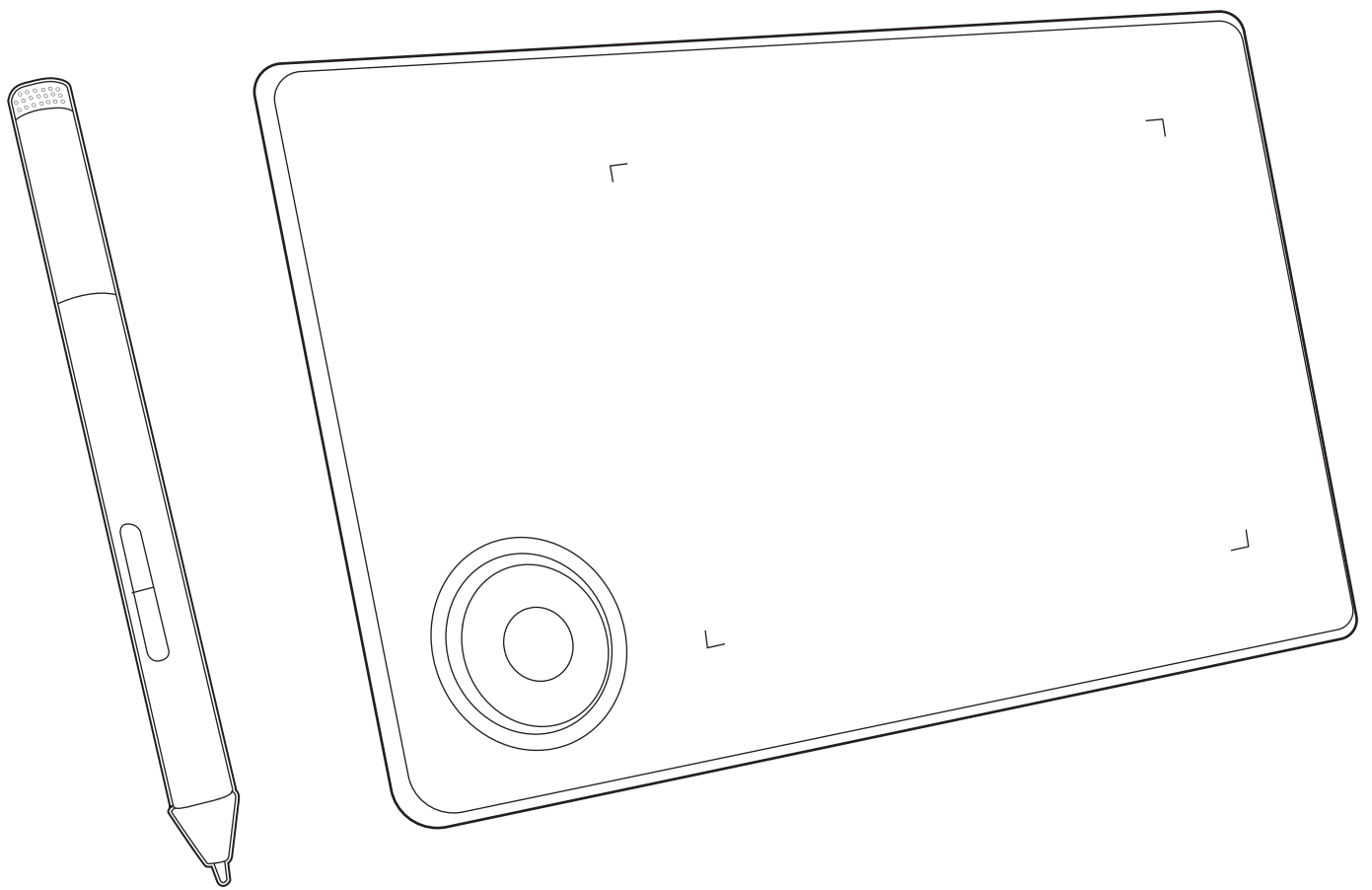

Digital Drawing Graphics Pen Tablet

AB22G505001



Searching for keywords

When working on a computer, to find a topic, search for keywords such as “pen” or “tablet”. In PDF viewer, press Ctrl+F on Windows® or Command+F on Mac to start searching.

Searching for a chapter

Read the Table of Contents below and tap/click on the desired chapter to jump to that chapter.

Printing this user manual

This user manual supports high resolution printing.

Table of Contents

1. Product Description	3
1.1 Graphics tablet	3
1.2 Accessories	3
2. Before First Use	4
3. Intended Use	4
4. Requirements	4
4.1 Software/hardware	4
4.2 Drivers	4
5. Connection and Driver Installation	5
5.1 For Windows®	5
5.2 For macOS®	8
5.3 For Android™ phone/tablet	12
6. Usage	12
7.1 Using the pen on the tablet	12
7.2 Using the tablet	15
8. Replacing the Pen Nib	18
9. Customizing Settings	19
9.1 For Windows®	19
9.2 For macOS®	22
10. Cleaning and Maintenance	24
10.1 Cleaning	24
10.2 Storage	24
11. Frequently Asked Questions	24
11.1 Windows®	24
11.2 macOS®	24
11.3 Android™	25
11.4 Usage	25
12. Trademarks	25
13. Specifications	25

1. Product Description

1.1 Graphics tablet

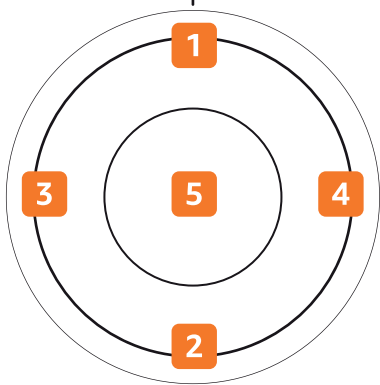
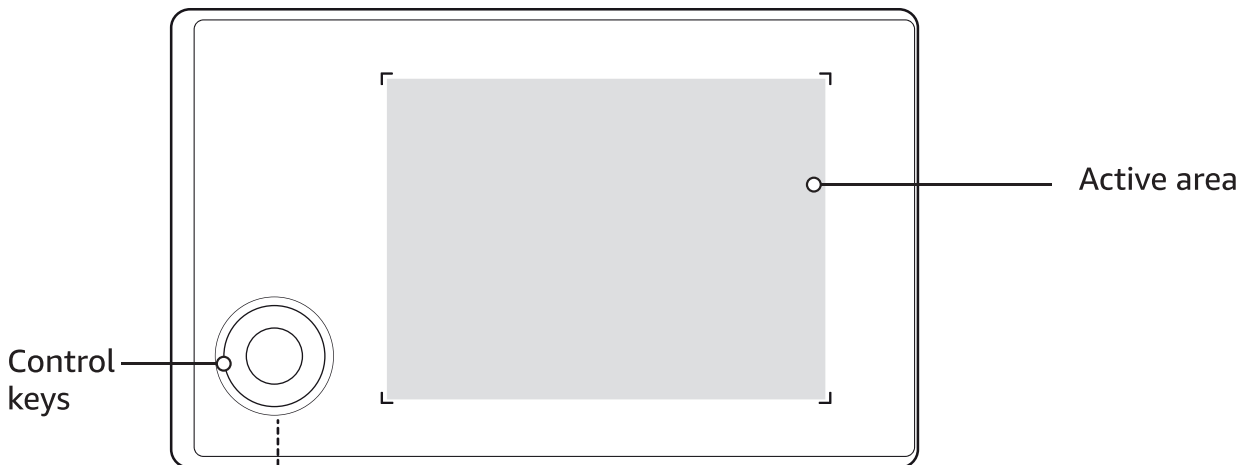

Key	Default function
Shortcut key 1	Canvas zoom in (Ctrl++ / Command++).
Shortcut key 2	Canvas zoom out (Ctrl+- / Command+-).
Shortcut key 3	Brush zoom in.
Shortcut key 4	Brush zoom out.
Roller key 5	Long press for setting up functions. (for Windows® only).

1.2 Accessories

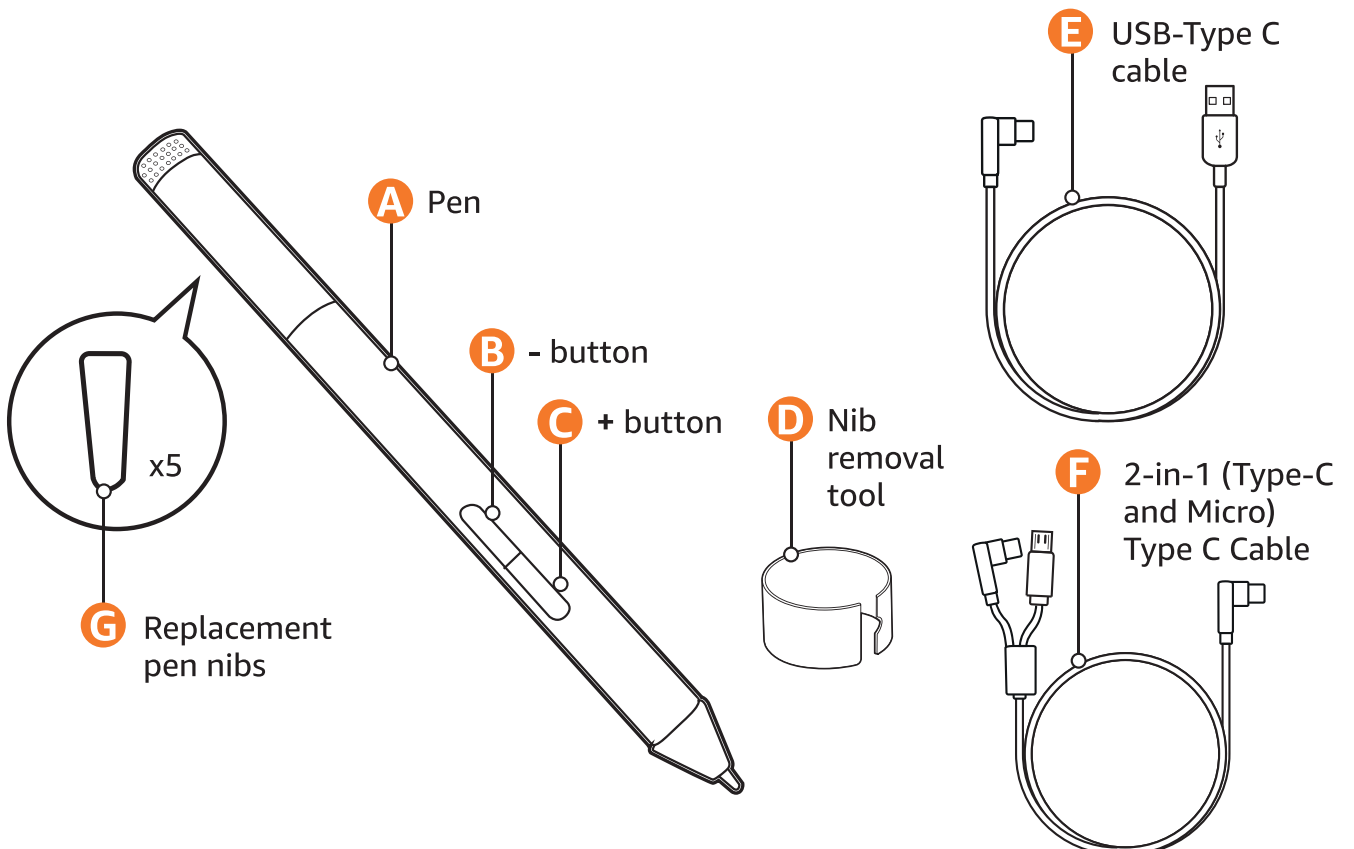

2. Before First Use

⚠ DANGER Risk of suffocation!

Keep any packaging materials away from children and pets – these materials are a potential source of danger, e.g. suffocation.

- ▶ Remove all the packing materials.
- ▶ Remove and review all components before use.
- ▶ Check the product for transport damages.

3. Intended Use

- ▶ This product is compatible with Windows 7/8/10 or later, macOS X 10.7 or later, and with Android devices supporting OTG with OS 6.0 or later.
- ▶ This product is compatible with most of the digital art software, such as Photoshop, Photoshop Lightroom, Illustrator, Clip Studio Paint, SketchBook Pro, Manga Studio, Corel Painter, FireAlpaca, openCanvas, PaintTool Sai, Krita, etc.
- ▶ This product is intended for private use only.
- ▶ This product is intended to be used in dry indoor areas only.
- ▶ Use the graphics tablet only with the pen included.

4. Requirements

DISCLAIMER It is the sole responsibility of the user for direct or indirect damages (including data loss) caused by the use of this product or its malfunction. Backup all important data as protection against data loss.

4.1 Software/hardware

In order for the product to operate as intended, the following software/hardware requirements are needed:

Operating system	<ul style="list-style-type: none"> ▶ Windows 7/8/10 or later ▶ macOS X 10.7 or later ▶ Android devices supporting OTG with OS 6.0 or later
Interface type	USB Type-C/ Micro-USB option for OTG

4.2 Drivers

A separate driver is required for this product. Connect the product to a compatible device and complete the driver installation.

- ▶ Windows: Open **Pen Driver** and run **Tablet_SetupV4**
- ▶ macOS: Open **Pen Driver** and run **TabletDriver.dmg**

NOTICE When connecting the product to an Android device, no driver is required.

5. Connection and Driver Installation

5.1 For Windows®

1. Connect the product to a compatible device using the USB-Type C cable (E) (Fig. 1).

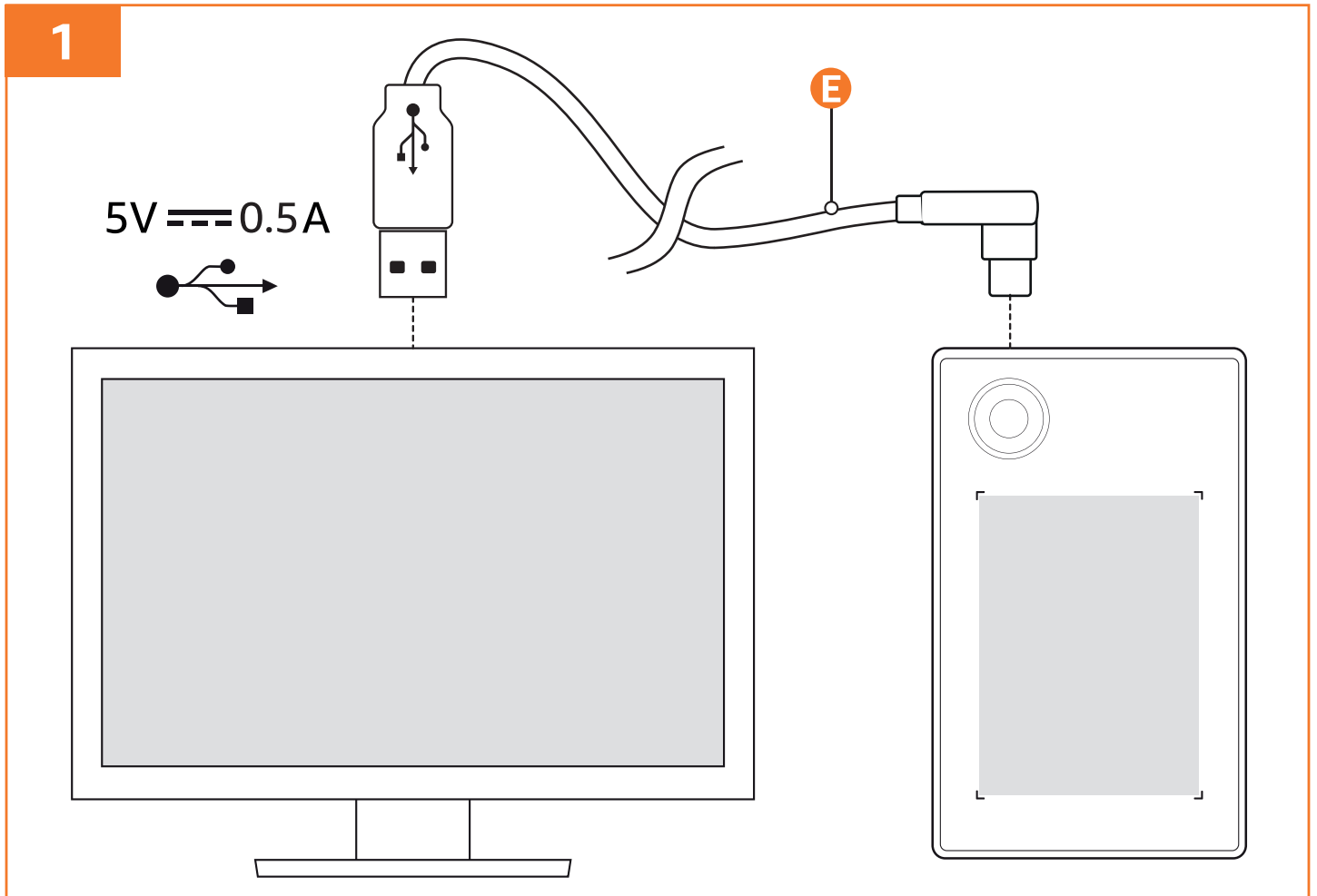

2. Open **Pen Driver** and run **Tablet_SetupV4** (Fig. 2).

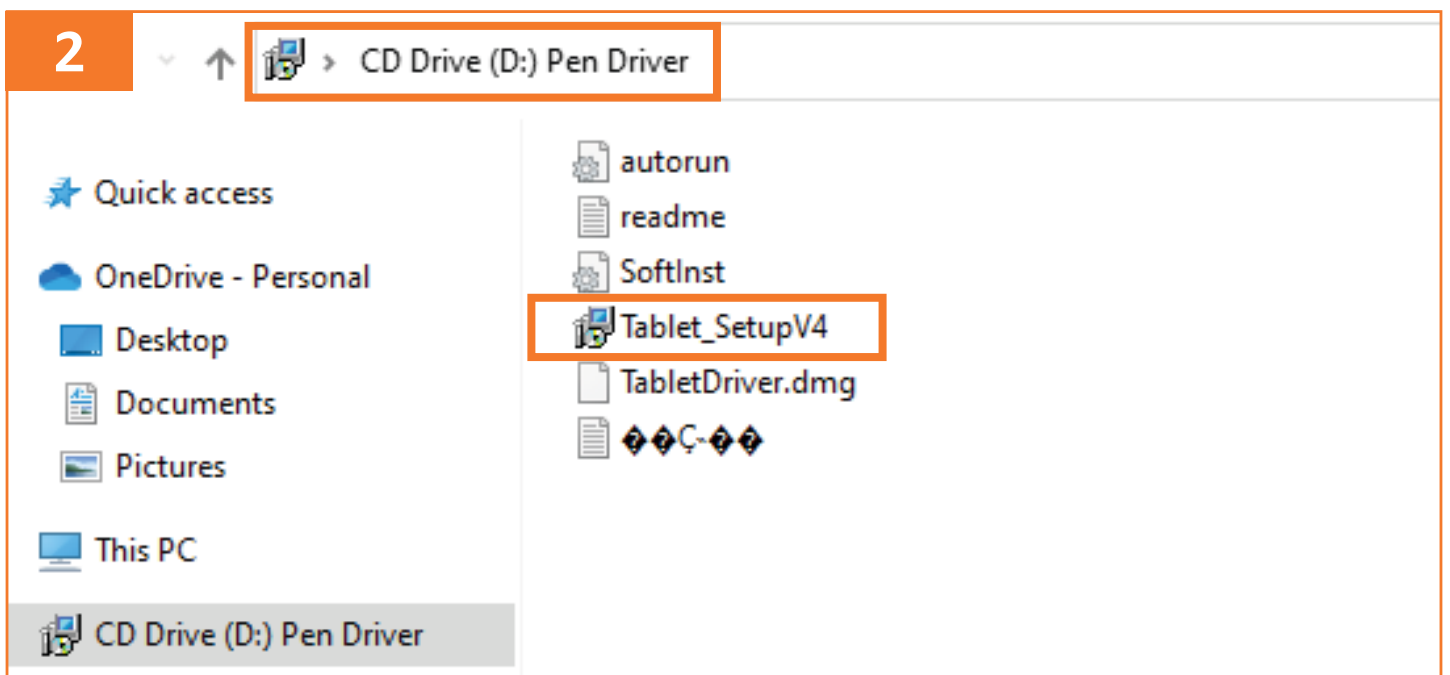

3. Select the desired language from the dropdown list and click **OK** (Fig. 3).

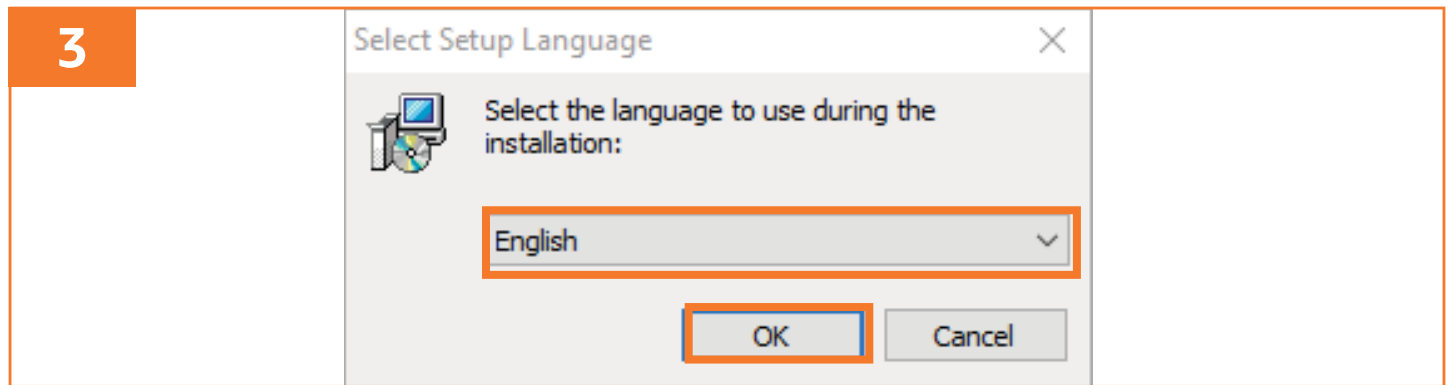

4. Click **Next >** to continue the installation (Fig. 4).

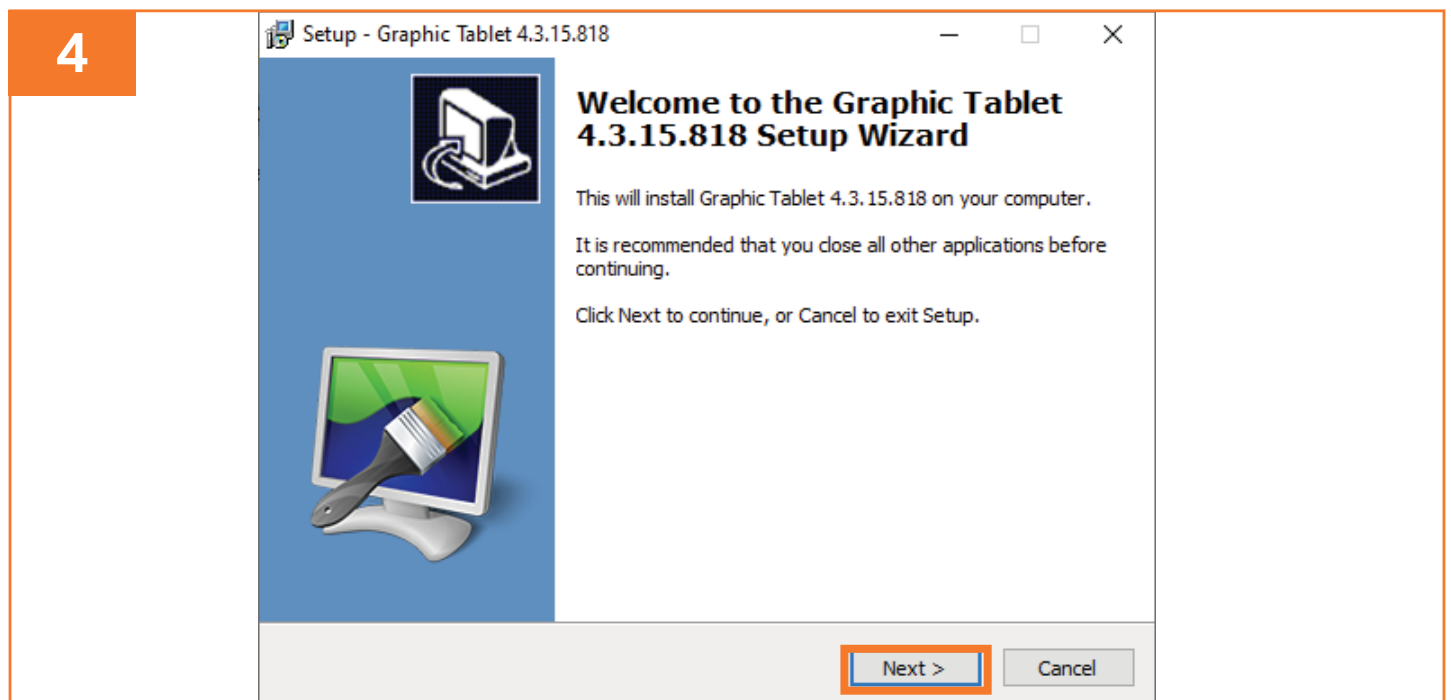

5. Select the destination folder and click **Next >**.

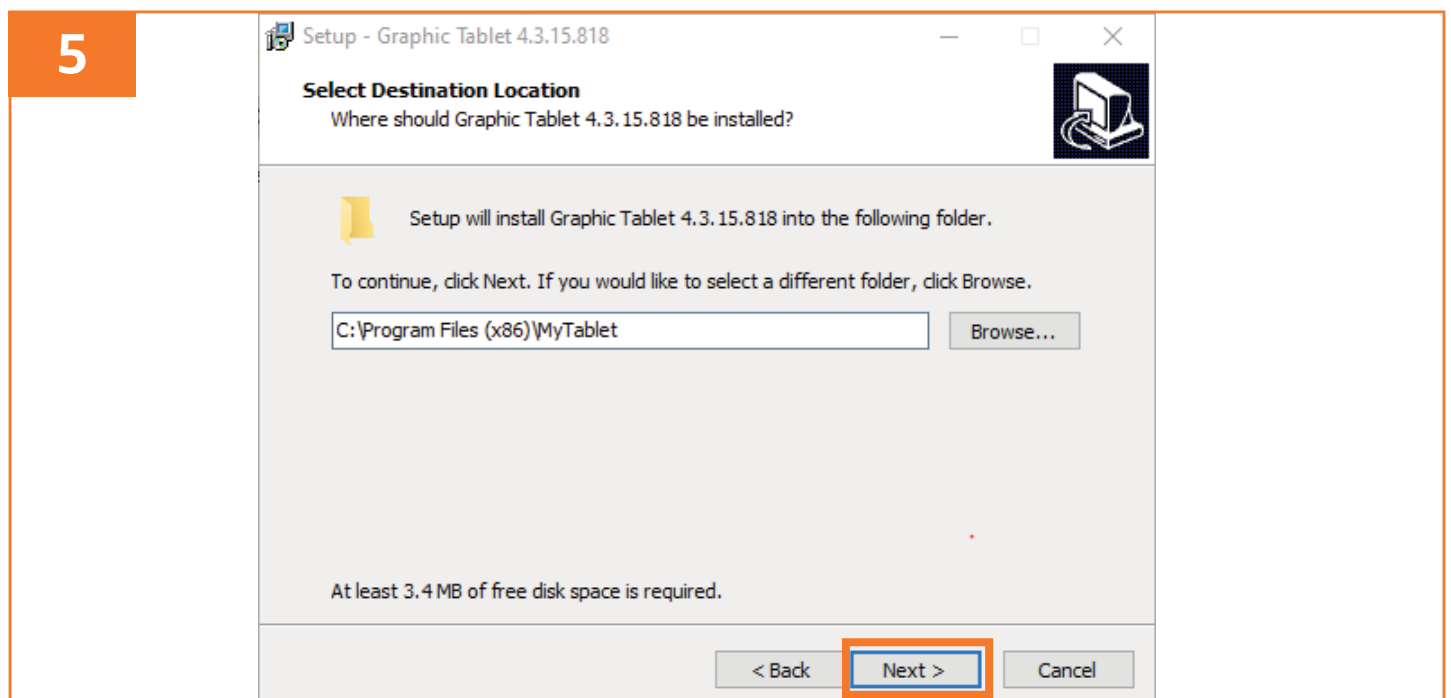

6. Click **Install** to start installing the driver (Fig. 6).

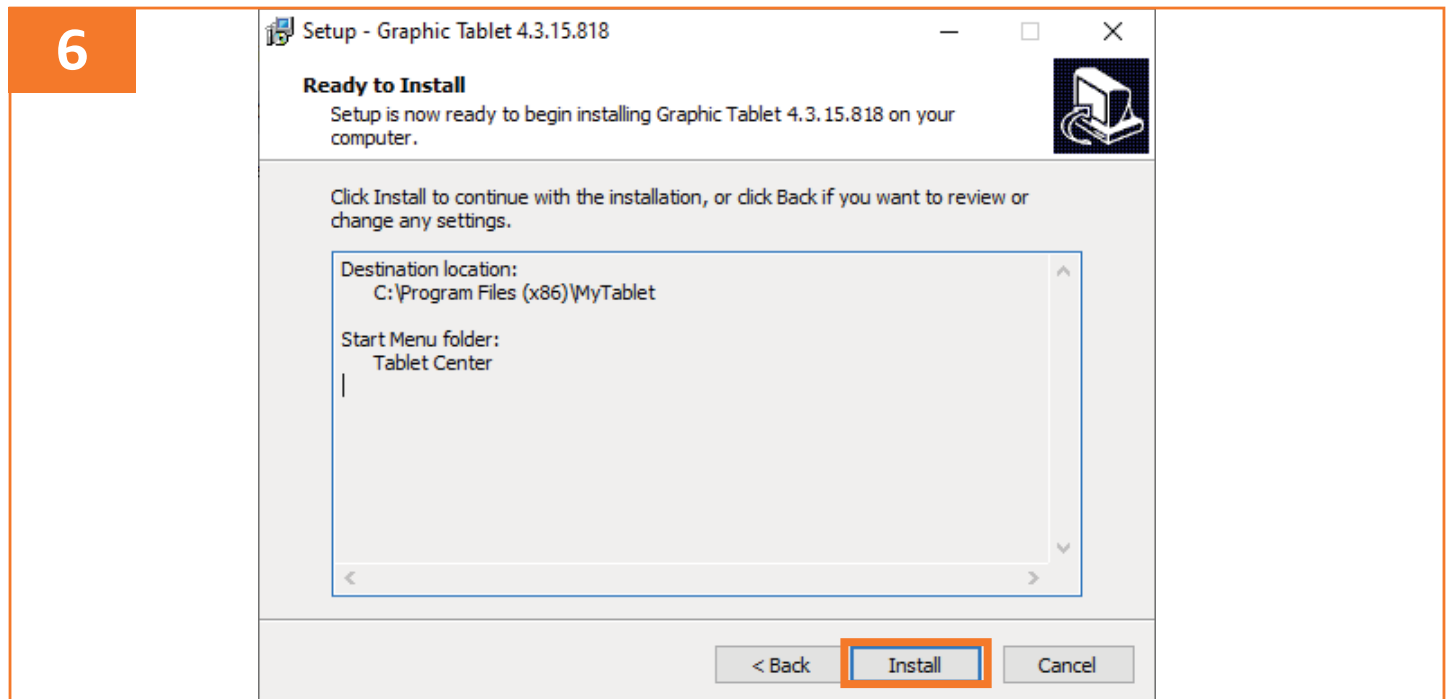

7. Check the checkbox and click **Finish** (Fig. 7).

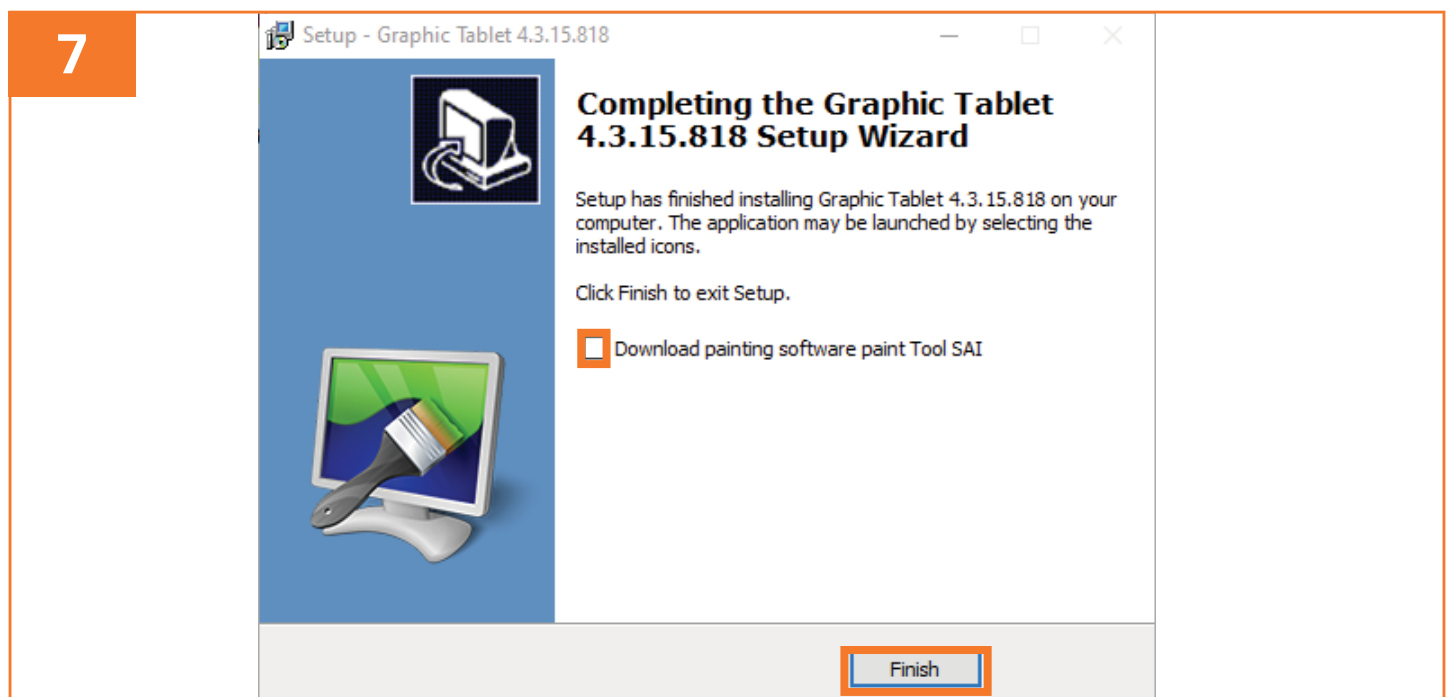

8. When the driver installation is completed, the "Graphic Tablet" software appears on the desktop and on the taskbar (Fig. 8).



NOTICE For Windows 7, disable flicks. Right click on the Flicks  icon in taskbar and select "turn off flicks".

5.2 For macOS®

1. Connect the product to a compatible device using the USB-Type C cable (E) or the 2-in-1 Type C Cable (F) (Fig. 1). Use a cable adapter (not included) if needed.

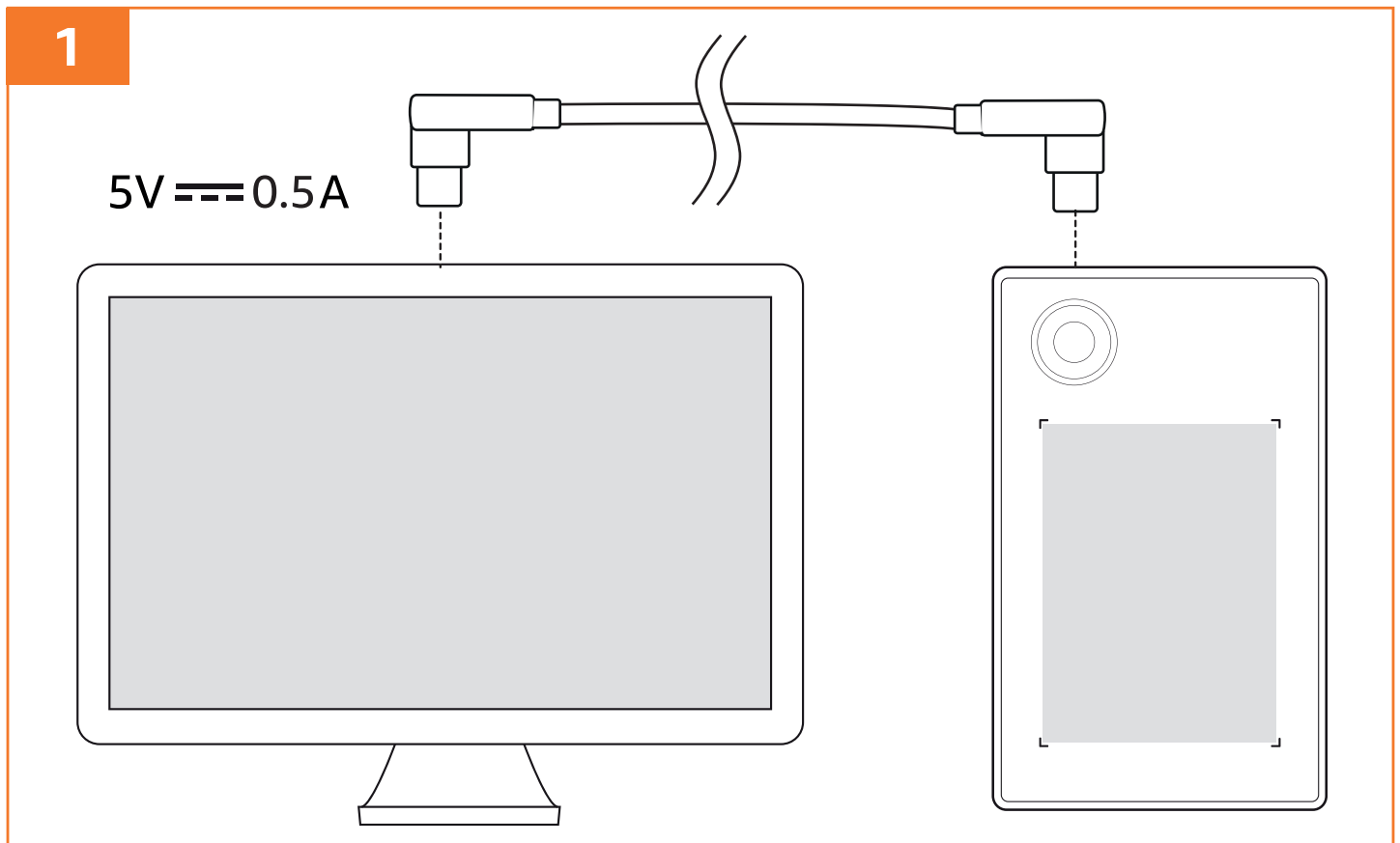

2. Open **Pen Driver** and run **TabletDriver.dmg** (Fig. 2).



3. Click **Continue**. (Fig. 3)

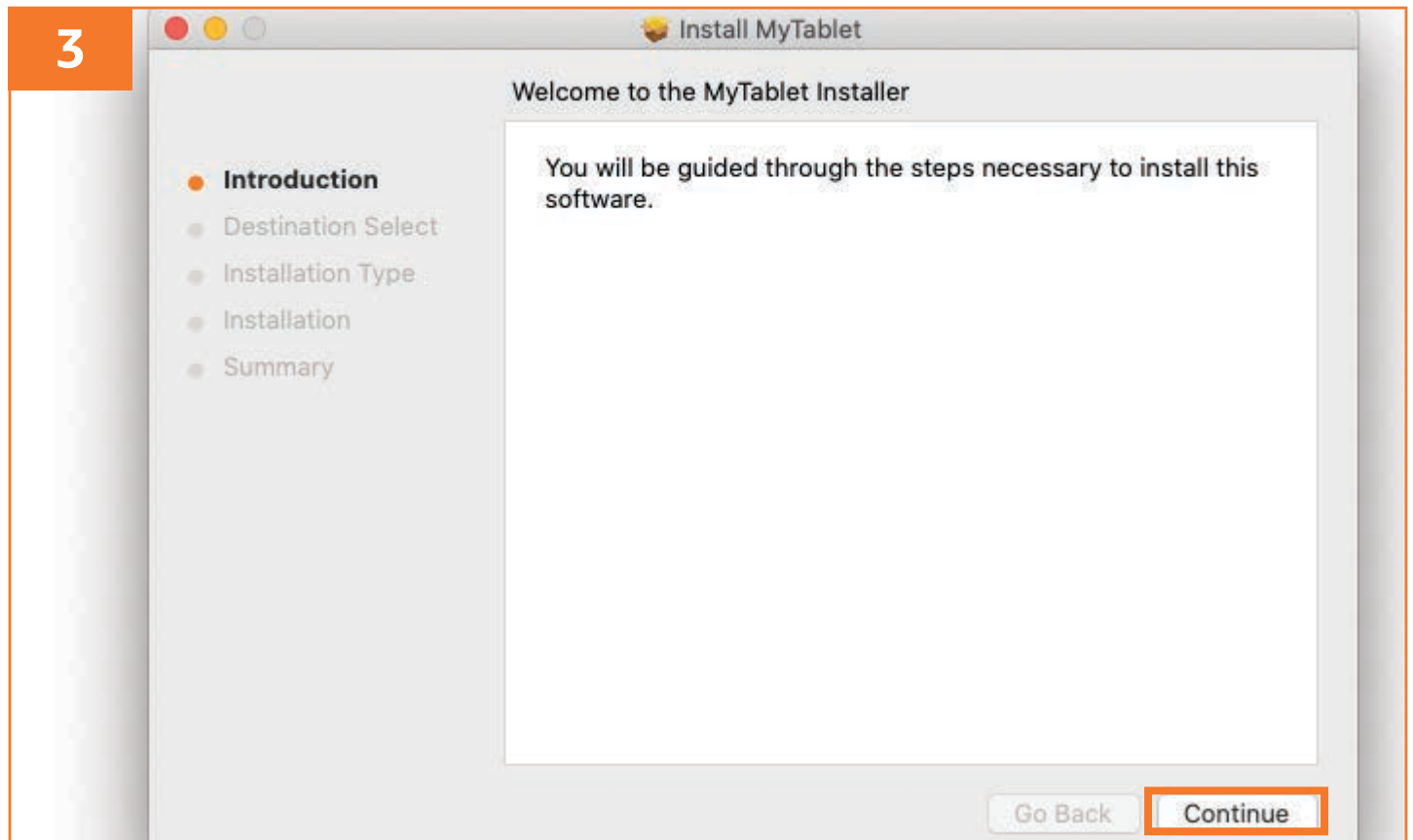

4. Select the desired destination folder and click **Install** (Fig. 4).

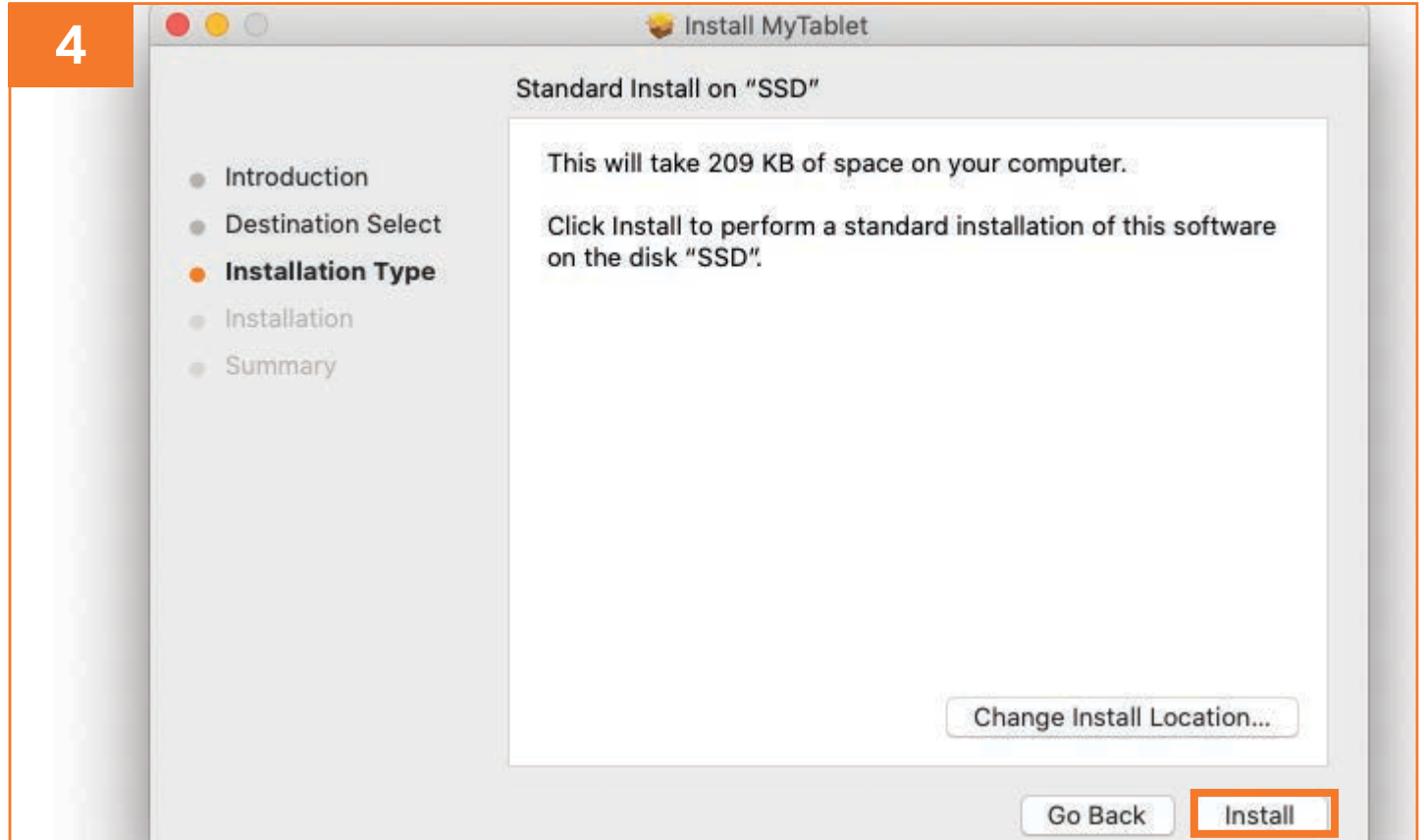

5. Enter the Username and Password, and click **Install Software** (Fig. 5).

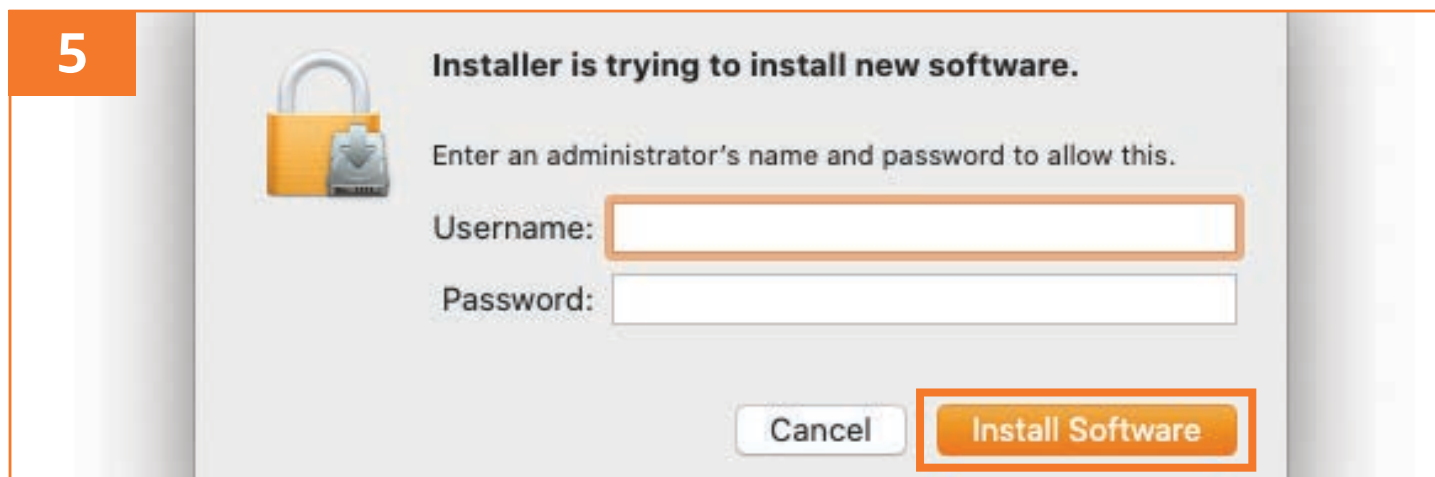

6. Click **Continue Installation** (Fig. 6).

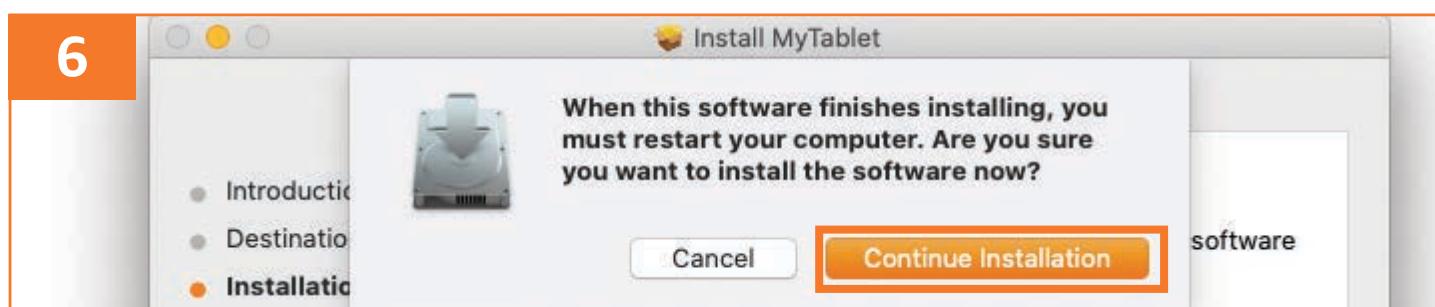

7. Click **Restart** (Fig. 7).

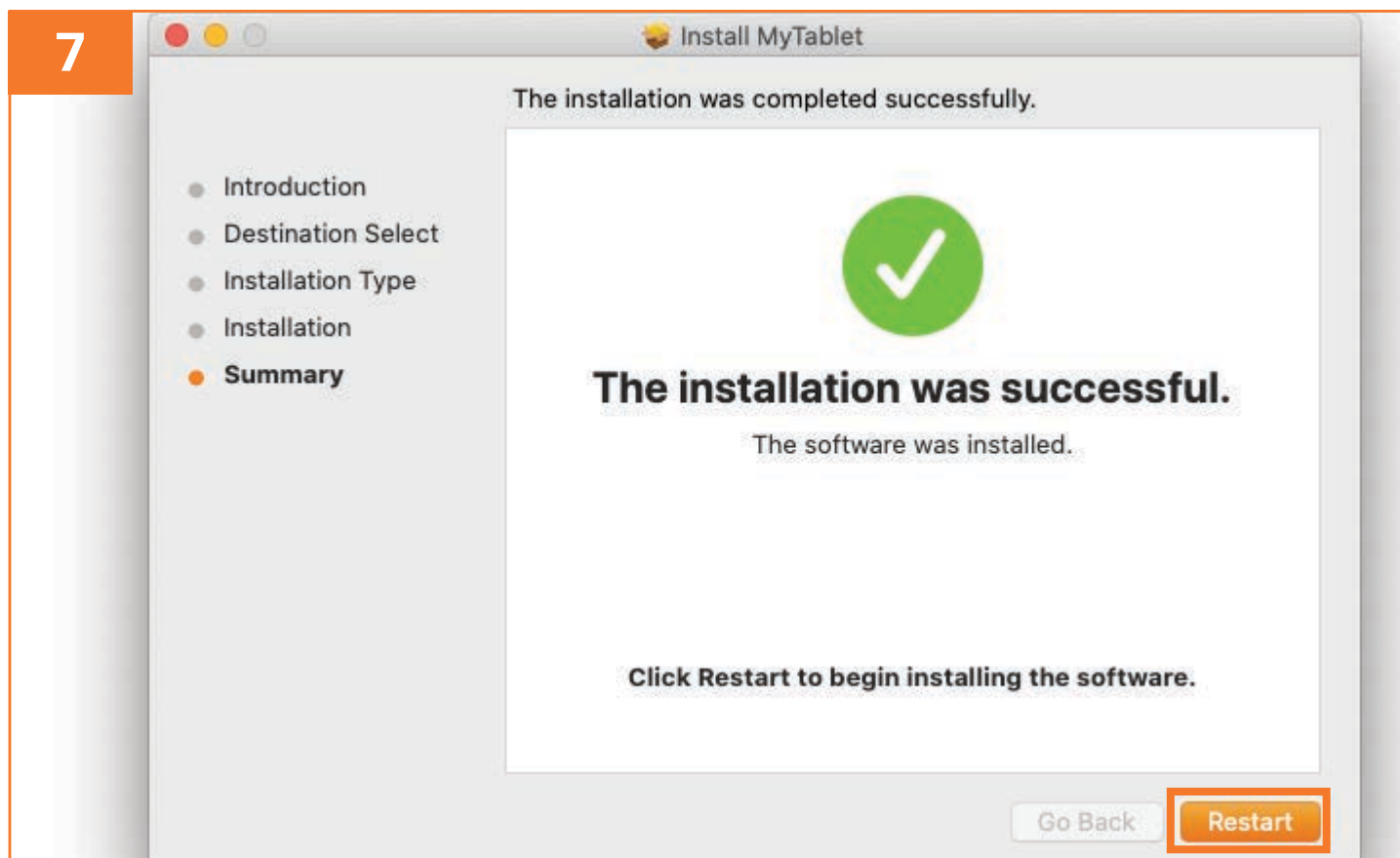

8. Select **System Preferences** from Apple menu . Open **Security & Privacy** (Fig. 8).

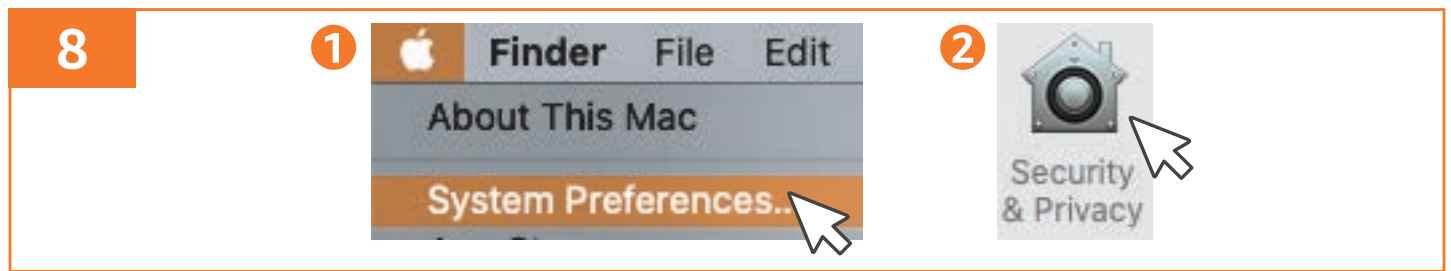

9. Open **Privacy** tab and select **Accessibility**. Click the lock icon and enter the administrator's name and password to follow changes. Check **MyTabletDaemon** (Fig. 9).

NOTICE

If **MyTabletDaemon** is not in the list, add it by clicking the + icon.

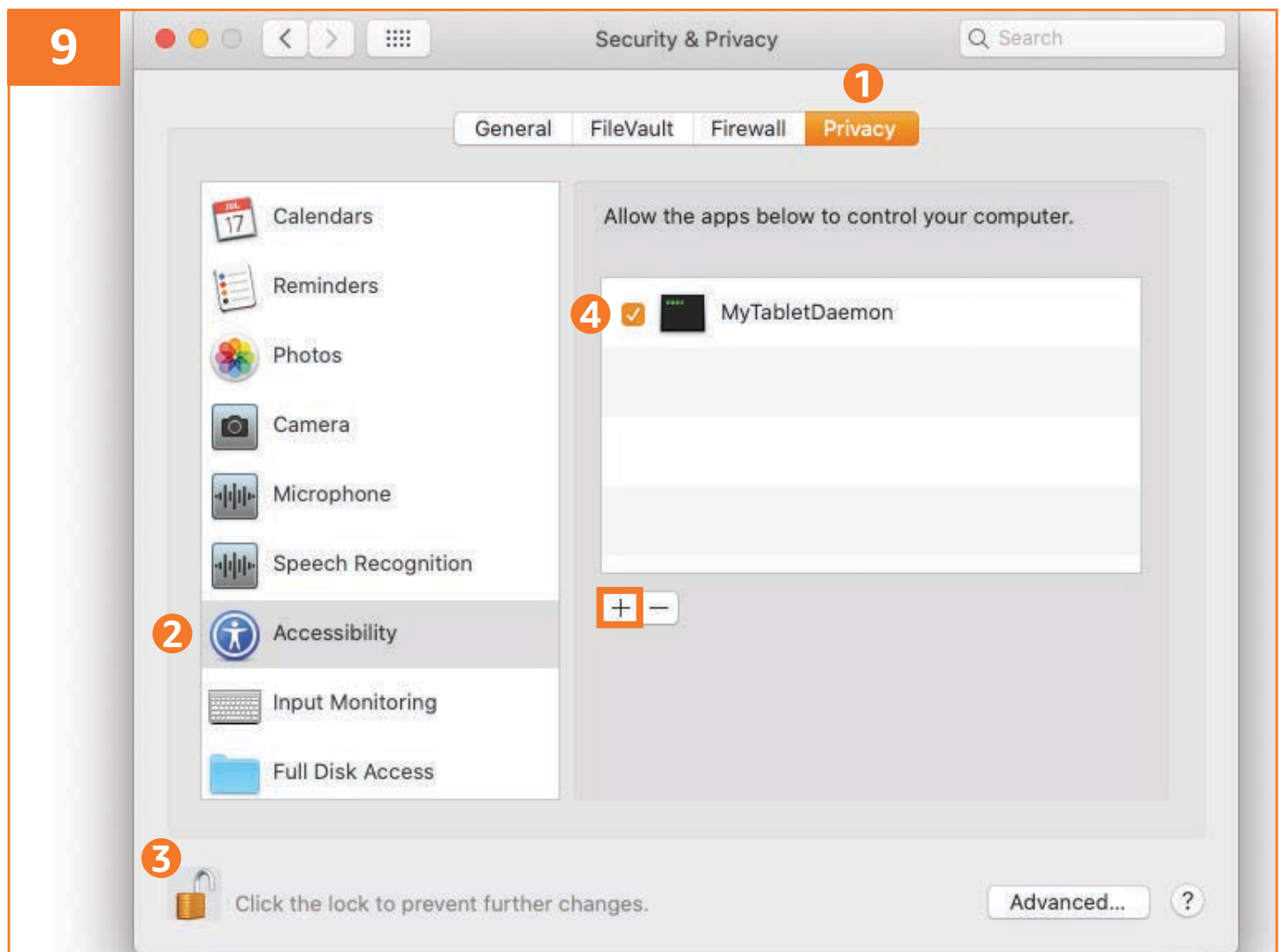

NOTICE

For macOS 10.15 or later, check **MyTabletDaemon** also in **Input Monitoring** and **Full Disk Access**.

5.3 For Android™ phone/tablet

NOTICE Disable “Auto-rotate screen” function from the Android device before connecting the product.

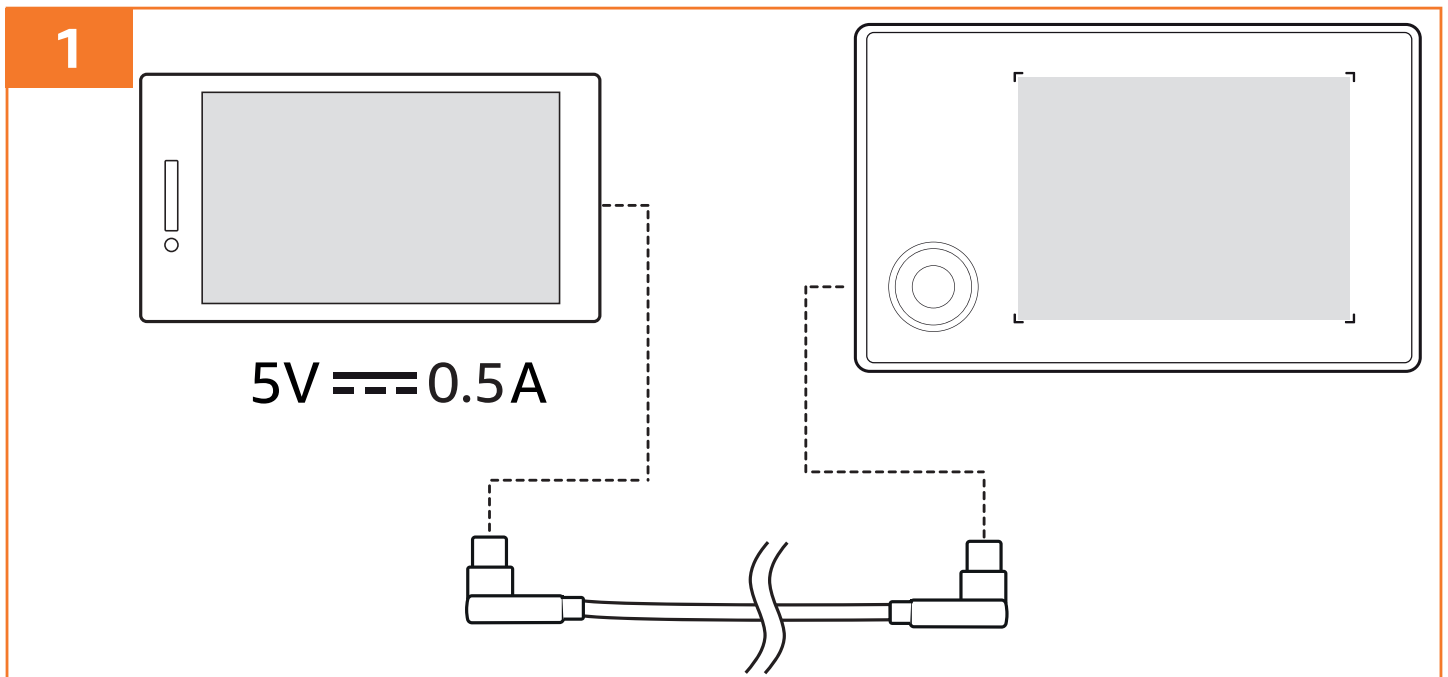

6. Usage

NOTICE Carefully peel the protective film off the tablet before use.

NOTICE When the pen (A) is not in use, lay it flat on the desk. Do not leave the pen (A) on the tablet as it interferes with screen cursor positioning when using other pointing devices, such as touchpad and mouse.

7.1 Using the pen on the tablet

NOTICE The active area is a mapped representation of the entire screen(s) of the connected computer(s) or phone.

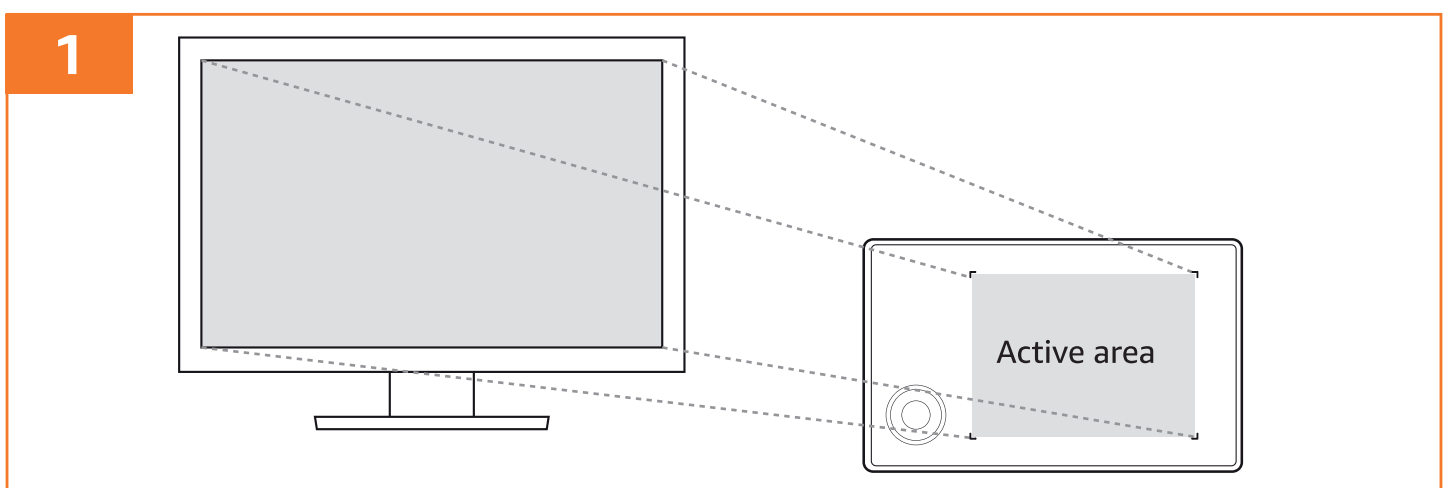

- Hold the pen (A) as holding a normal pen or pencil. Adjust the pen (A) so that the buttons (B/ C) can be easily toggled with the thumb or forefinger (Fig. 2).

2

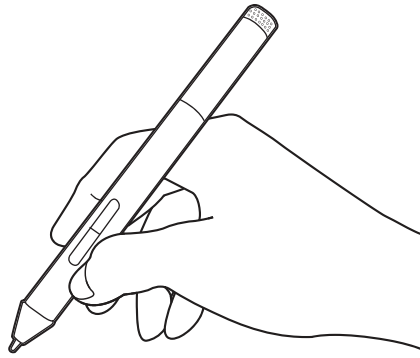

- Press the - button (B) to undo changes (same as shortcut key **Ctrl+Z** on Windows or **Command+Z** on macOS). Press the + button (C) for a right-click on mouse.

NOTICE The function of the - button (B) can be customized. Refer to **Customizing Settings**.

- To move the screen cursor, hover the pen (A) over the active area of the tablet (Fig. 3). Keep the pen nib within 15 mm above the tablet surface without touching.

3

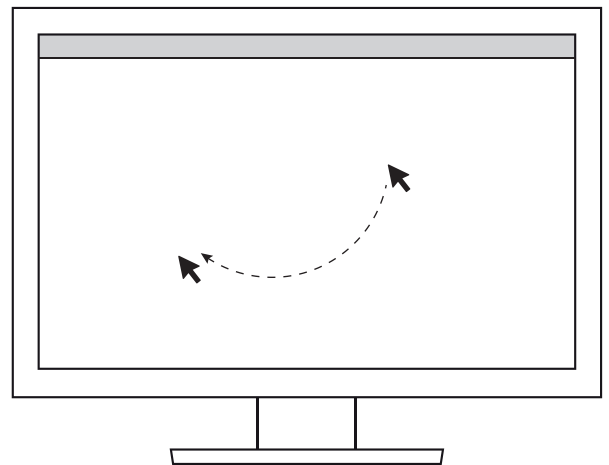
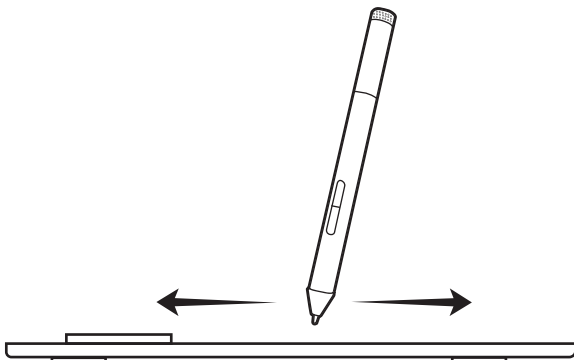

- To click to highlight or select an object on the screen, tap the pen nib once on the tablet (Fig. 4).

4

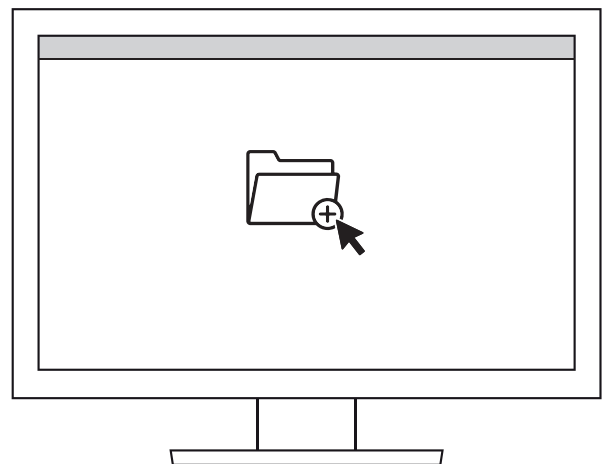
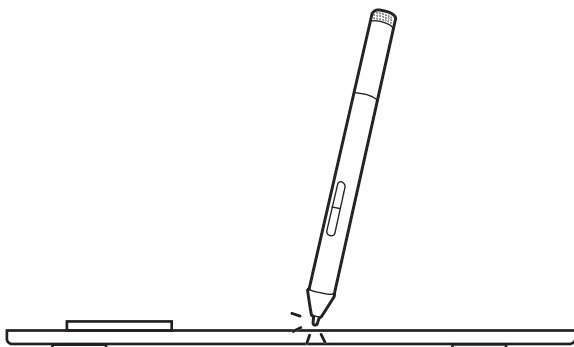

- ▶ To drag objects on the screen, press the pen nib to the tablet and slide it across for the move (Fig. 5).

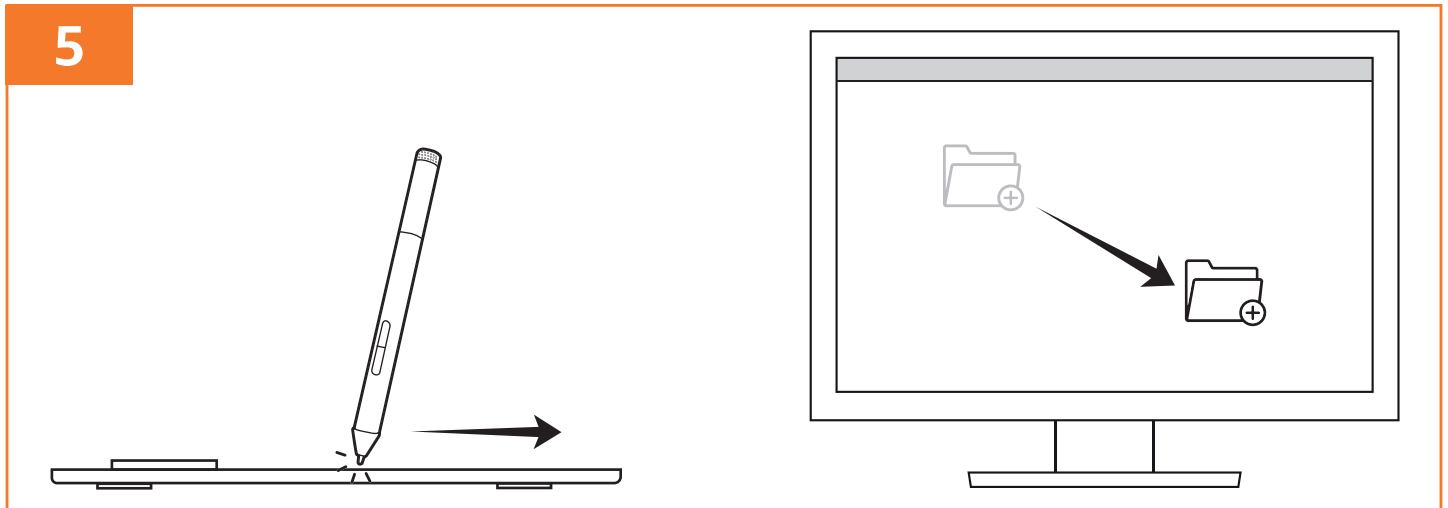

- ▶ To write or sketch with pressure sensitivity, use the pen (A) while applying different amounts of pressure downward on the tablet surface. Press harder for thicker lines or denser colour; press lighter for thin lines or softer colour (Fig. 6).

NOTICE Perform proper settings of the digital art software to allow pressure sensitivity.

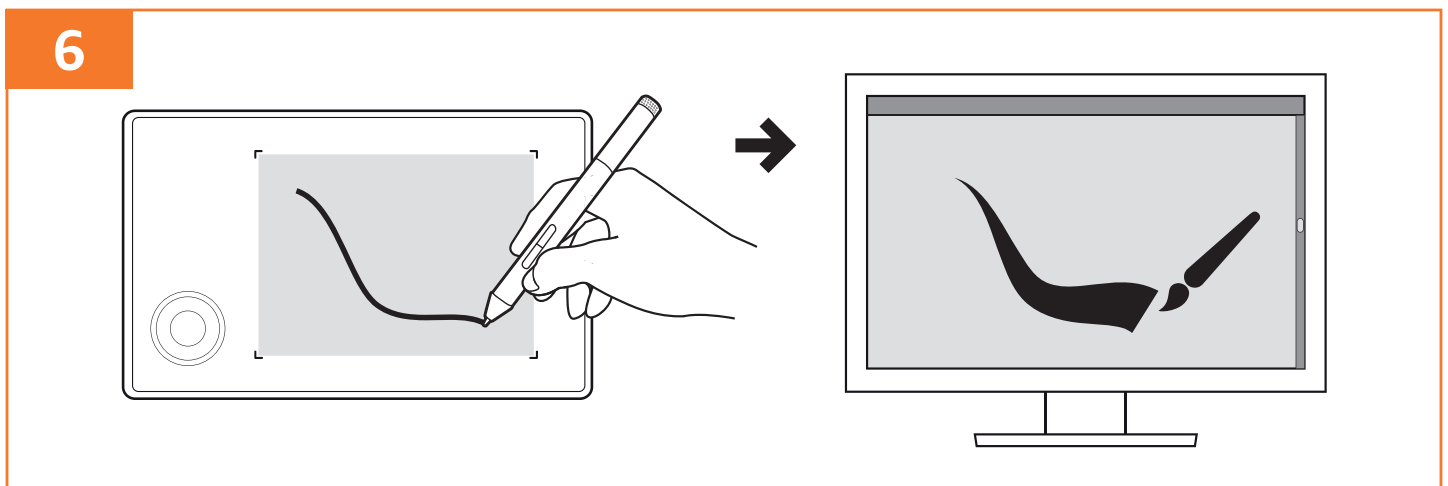

- ▶ Use the pen (A) to edit images within a digital art software (Fig. 7).

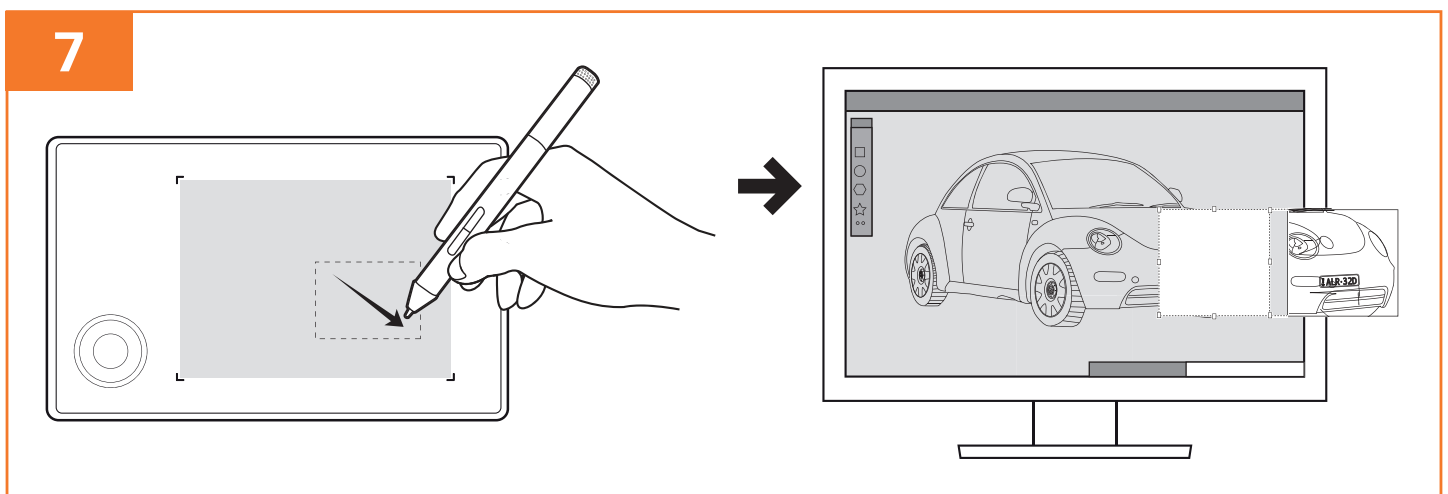

- Use the pen (A) to digitally mark on documents (Fig. 8).

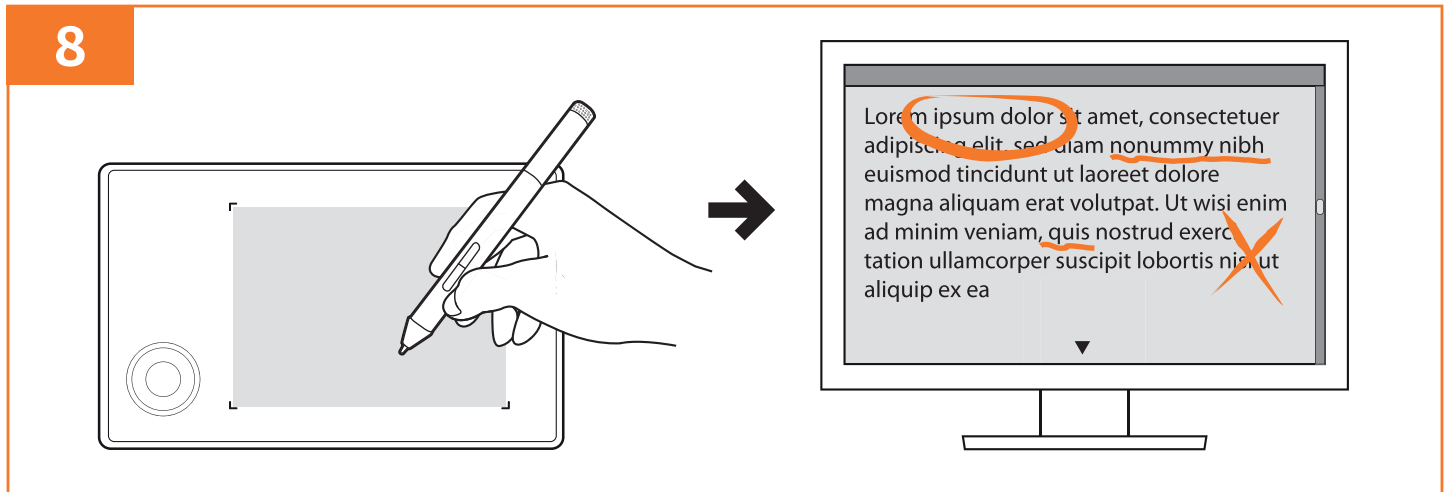

7.2 Using the tablet

7.2.1 Control keys

Use the control keys on the tablet for quick actions.

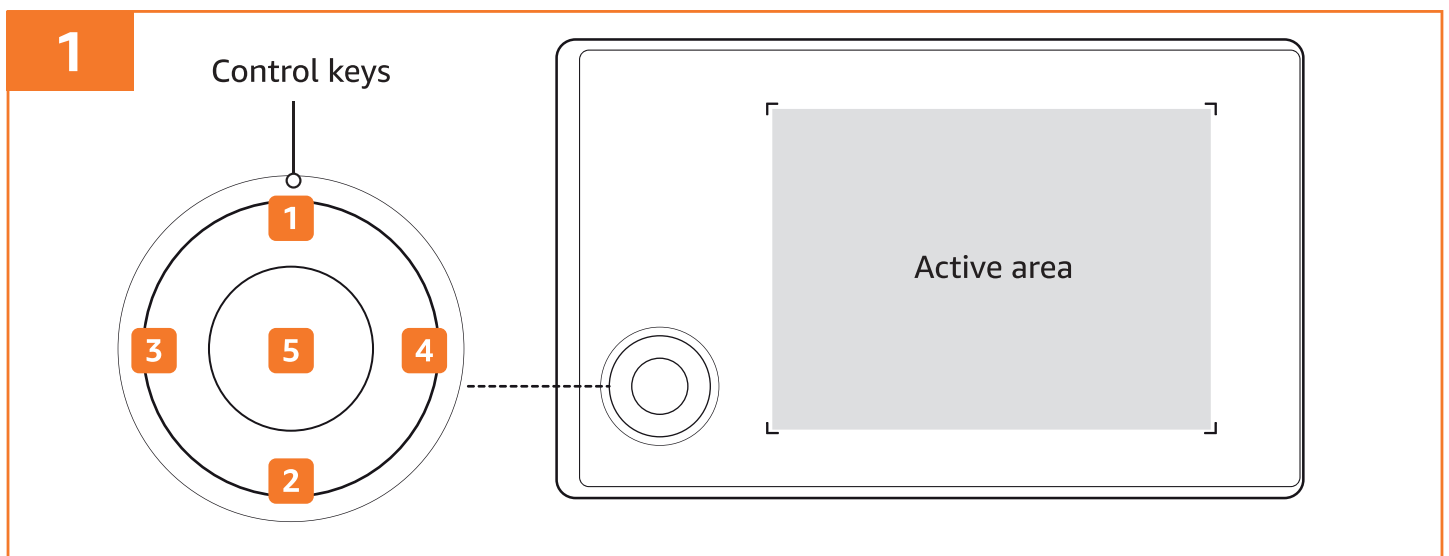

Key	Default function
Shortcut key 1	Canvas zoom in (Ctrl++ / Command++).
Shortcut key 2	Canvas zoom out (Ctrl+- / Command+-).
Shortcut key 3	Brush zoom in.
Shortcut key 4	Brush zoom out.
Roller key 5	Long press for setting up functions (for Windows® only).

NOTICE The function of the shortcut keys can be customized. Refer to **Customizing Settings**.

7.2.2 Roller key

NOTICE Setting up functions using the roller key can only be done in Windows®.

Long press on the roller key and rotate the roller key to enter the corresponding setting.

1



The roller key is shown with a blue highlight on the top segment, which is labeled "Mouse Wheel". The central text "Mouse Wheel" is also highlighted in blue. The roller key has several other segments with icons: a speaker, a list, a square with four arrows, a keyboard, a power button, and a refresh icon.

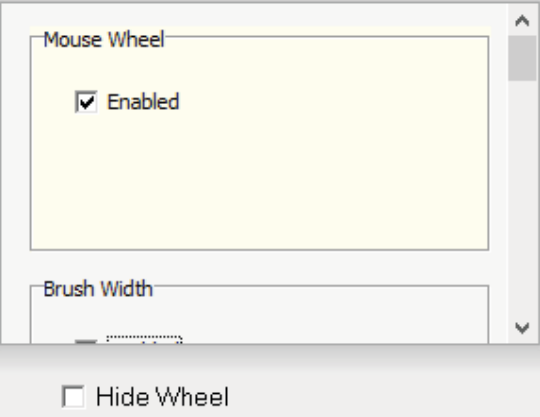

The screenshot shows the "Mouse Wheel" settings window. The "Enabled" checkbox is checked. Below it, the "Brush Width" section is partially visible. At the bottom, there is a "Hide Wheel" checkbox which is unchecked.

2

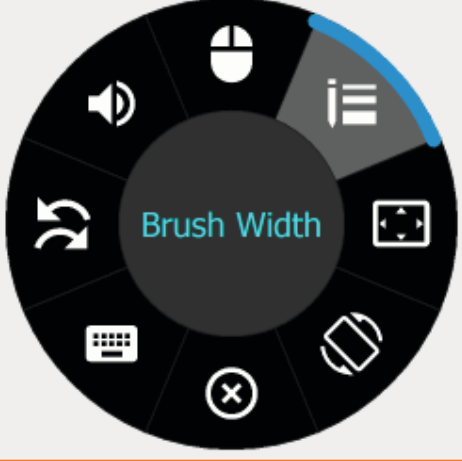

The roller key is shown with a blue highlight on the top-right segment, which is labeled "Brush Width". The central text "Brush Width" is also highlighted in blue. The roller key has several other segments with icons: a speaker, a list, a square with four arrows, a keyboard, a power button, and a refresh icon.

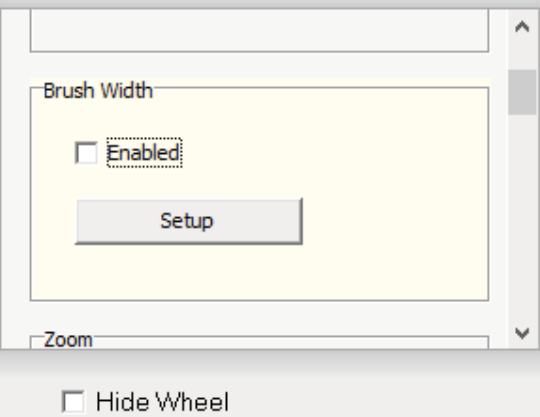

The screenshot shows the "Brush Width" settings window. The "Enabled" checkbox is unchecked. Below it is a "Setup" button. At the bottom, there is a "Zoom" section and a "Hide Wheel" checkbox which is unchecked.

3

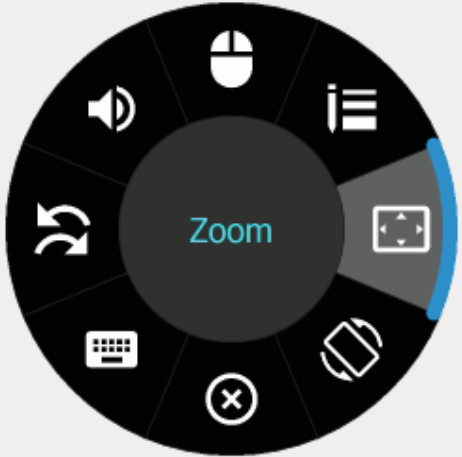

The roller key is shown with a blue highlight on the top-right segment, which is labeled "Zoom". The central text "Zoom" is also highlighted in blue. The roller key has several other segments with icons: a speaker, a list, a square with four arrows, a keyboard, a power button, and a refresh icon.

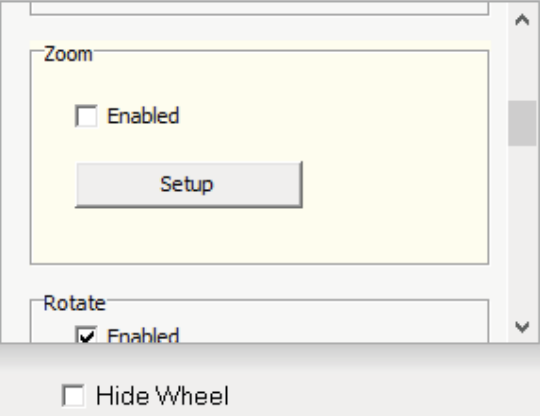

The screenshot shows the "Zoom" settings window. The "Enabled" checkbox is unchecked. Below it is a "Setup" button. Below that is the "Rotate" section, where the "Enabled" checkbox is checked. At the bottom, there is a "Hide Wheel" checkbox which is unchecked.

4

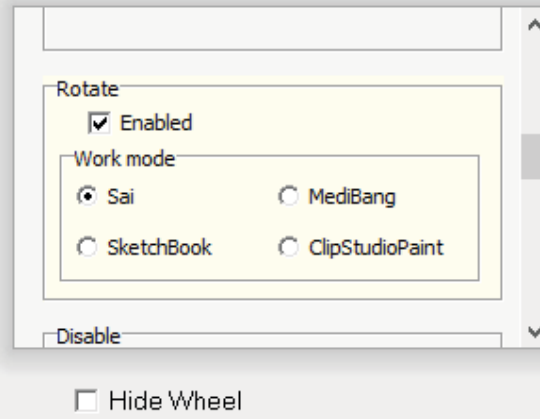

5

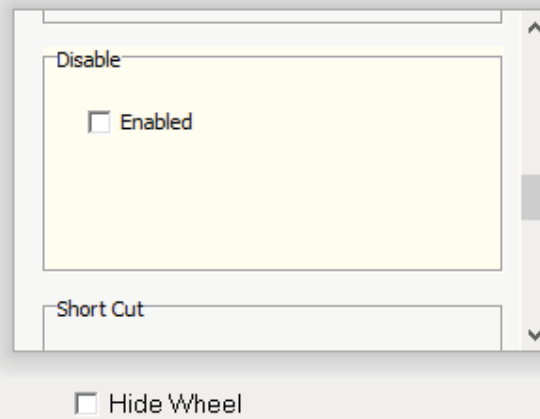

6

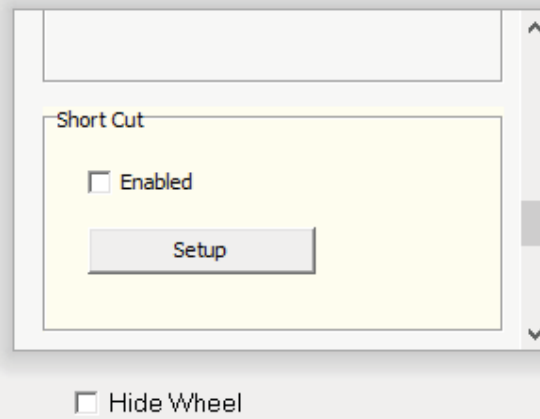
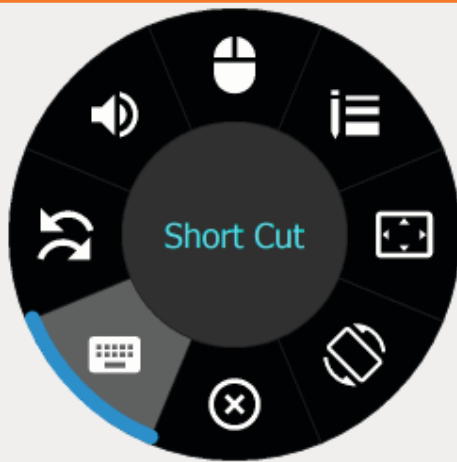

7

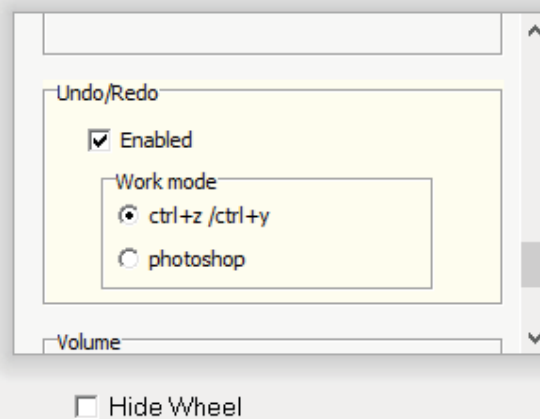

8

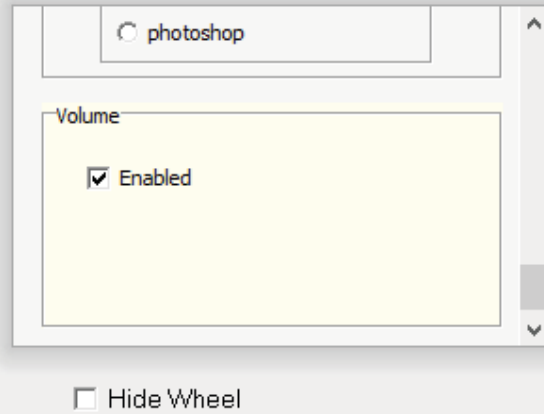
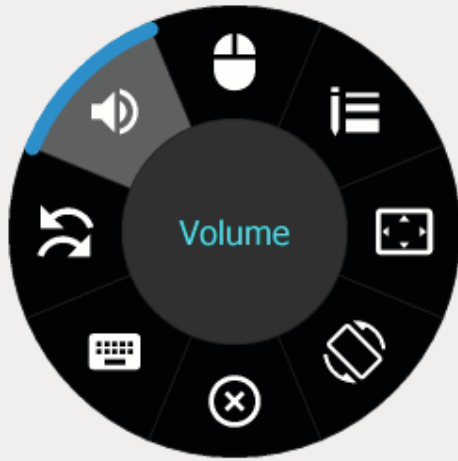

8. Replacing the Pen Nib

DANGER Choking hazard!

Keep the small parts, i.e. replacement pen nibs (E), away from children.

NOTICE The pen nib wears out with time. Replace a new pen nib (E) when it gets too short (i.e. <math>< 1\text{ mm}</math>) or develops a flat point.

1

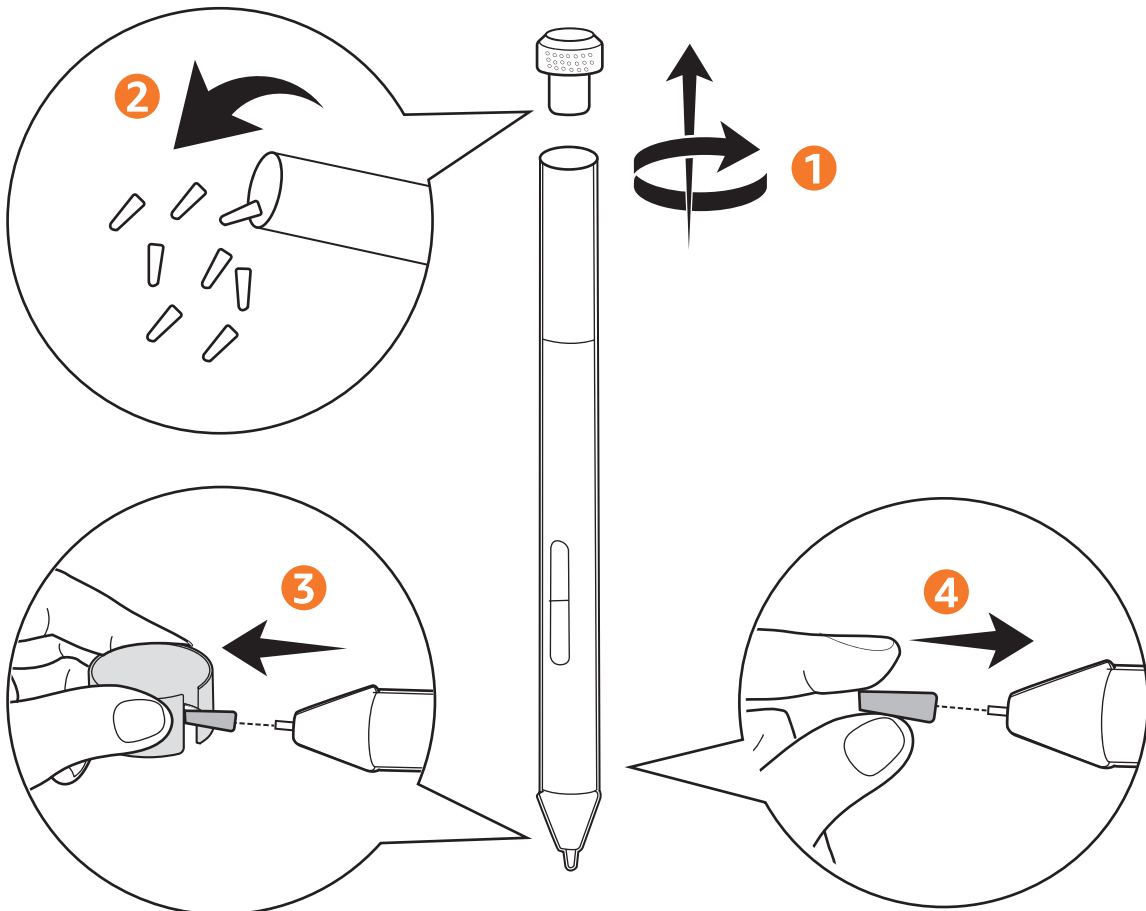

1. Unscrew the end cap of the pen (A) and carefully take a replacement pen nib (G) out (Fig. 1).
2. Clasp the old nib using the nib removal tool (D). Pull it straight out of the pen (A).
3. Firmly push a new replacement pen nib (G) into the pen (A) until it stops.

9. Customizing Settings

NOTICE When using the product with Android™ device, pen/tablet settings cannot be customized.

9.1 For Windows®

Open the “Graphic Tablet” software to customize the settings.

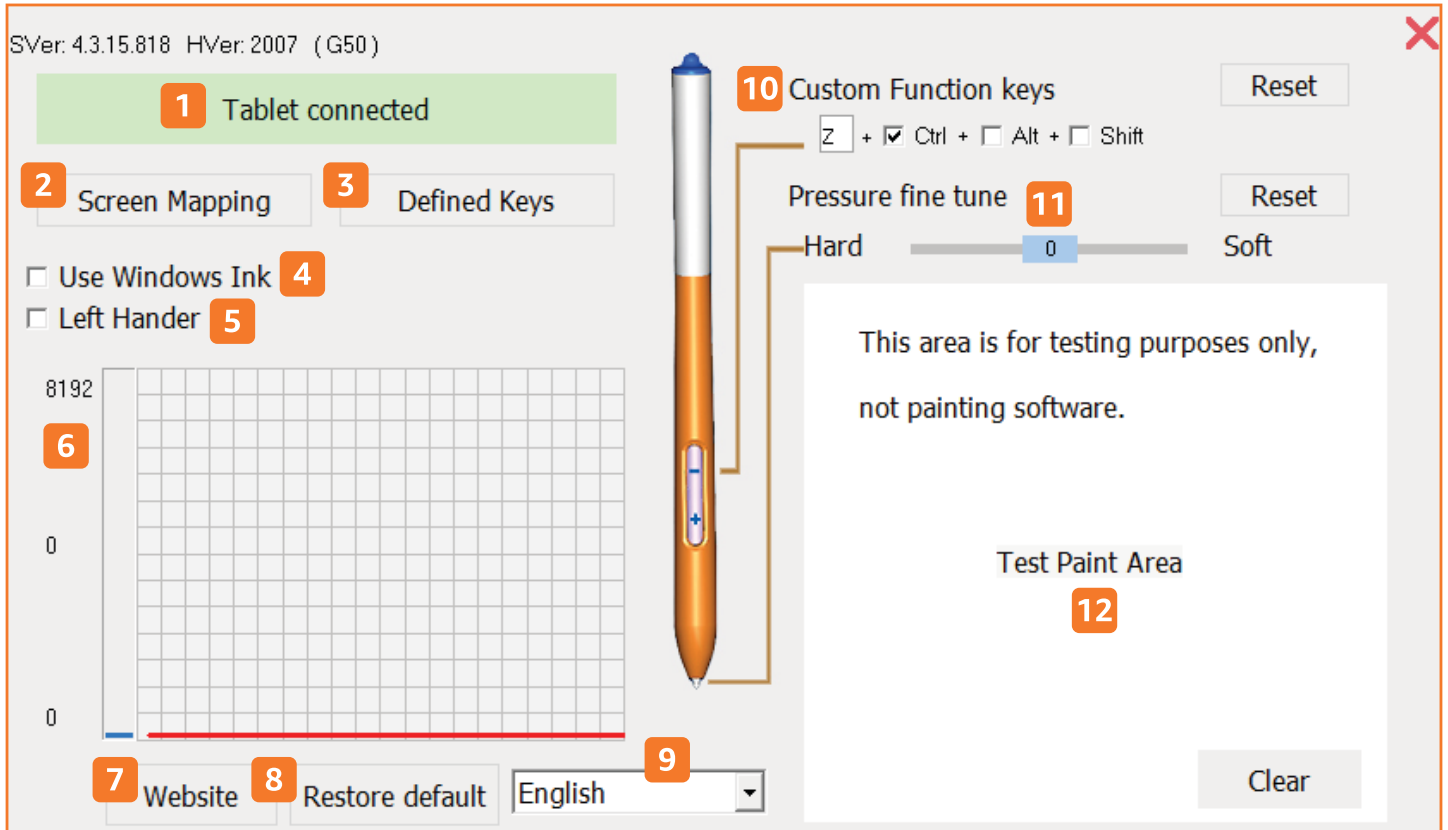

- 1 To show the connection status.
- 2 To modify the screen mapping area and the active area of the tablet.
- 3 To customize the functions of the shortcut keys on the tablet.
- 4 Tick when using Microsoft Office.
- 5 Tick for left-handed usage.
- 6 To show the pressure level.
- 7 To access this user manual
- 8 To restore default settings.
- 9 To change the language.
- 10 To customize the function of the - button on the pen.
- 11 To fine-tune the pen pressure.
- 12 The test paint area for testing the pen pressure.

9.1.1 Screen mapping

NOTICE

- ▶ When the product is connected to a computer equipped with more than one monitor in extended monitor mode, the tablet maps to all monitors.
- ▶ When the product is connected to a computer equipped with more than one monitor in mirror mode, the tablet maps to the entire screen on each monitor and the screen cursor is displayed on each monitor simultaneously.

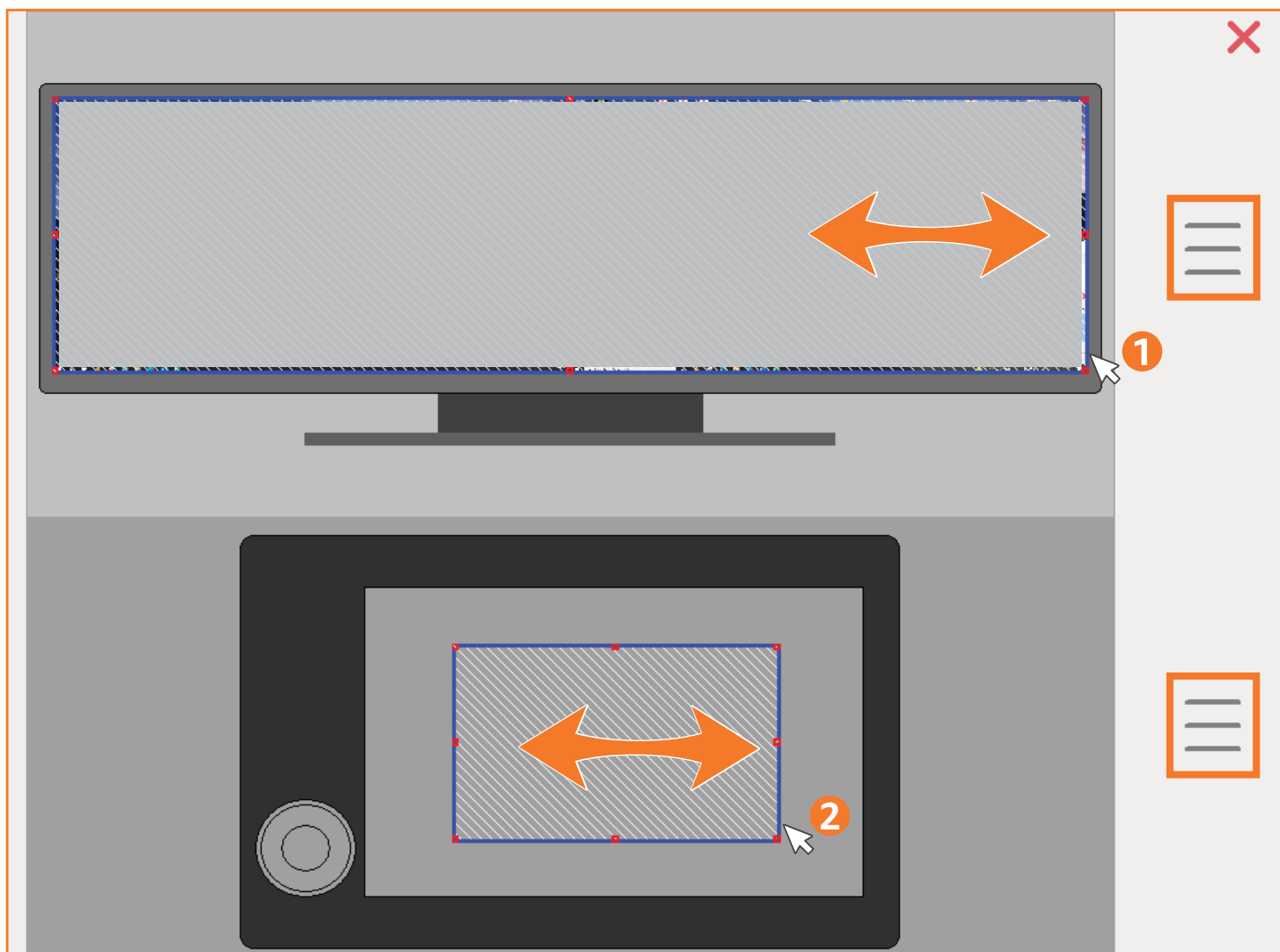

- ▶ Customize the tablet to map to a portion of the monitor area by dragging the frame freely.
- ▶ Customize the active area of the tablet to screen mapping by dragging the frame freely.

NOTICE

To adjust the monitor area or active area proportionally, click the ☰ icon on the side.

9.1.2 Defined keys

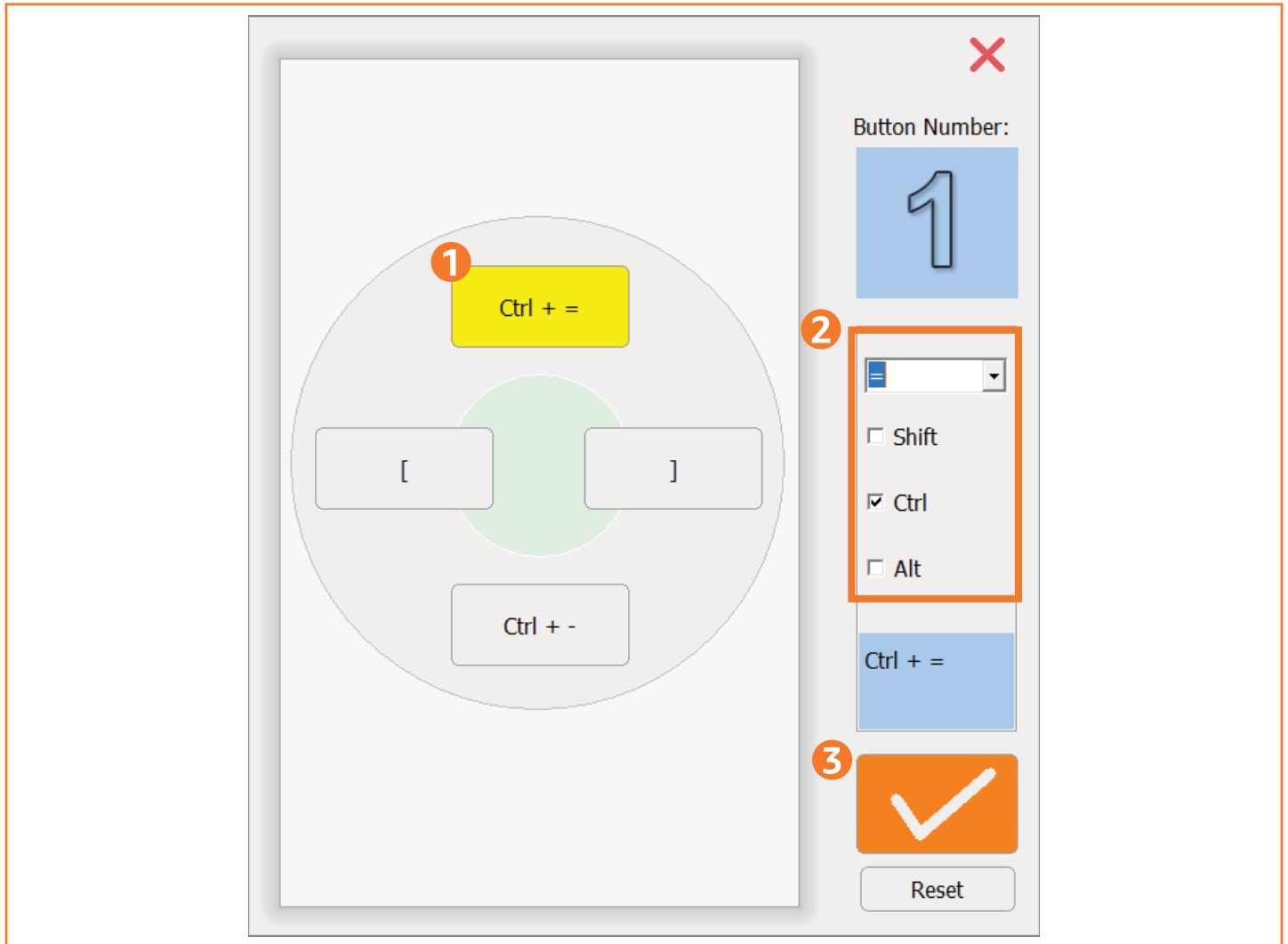

1. Click the shortcut key to be customized. The corresponding key is highlighted in yellow.
2. Set the function of the key by selecting an option from the drop-down list and checking/unchecking boxes.
3. Click the tick icon to confirm the changes.

9.2 For macOS®

1. Open “Tablet Setting” software from Applications to customize the settings.

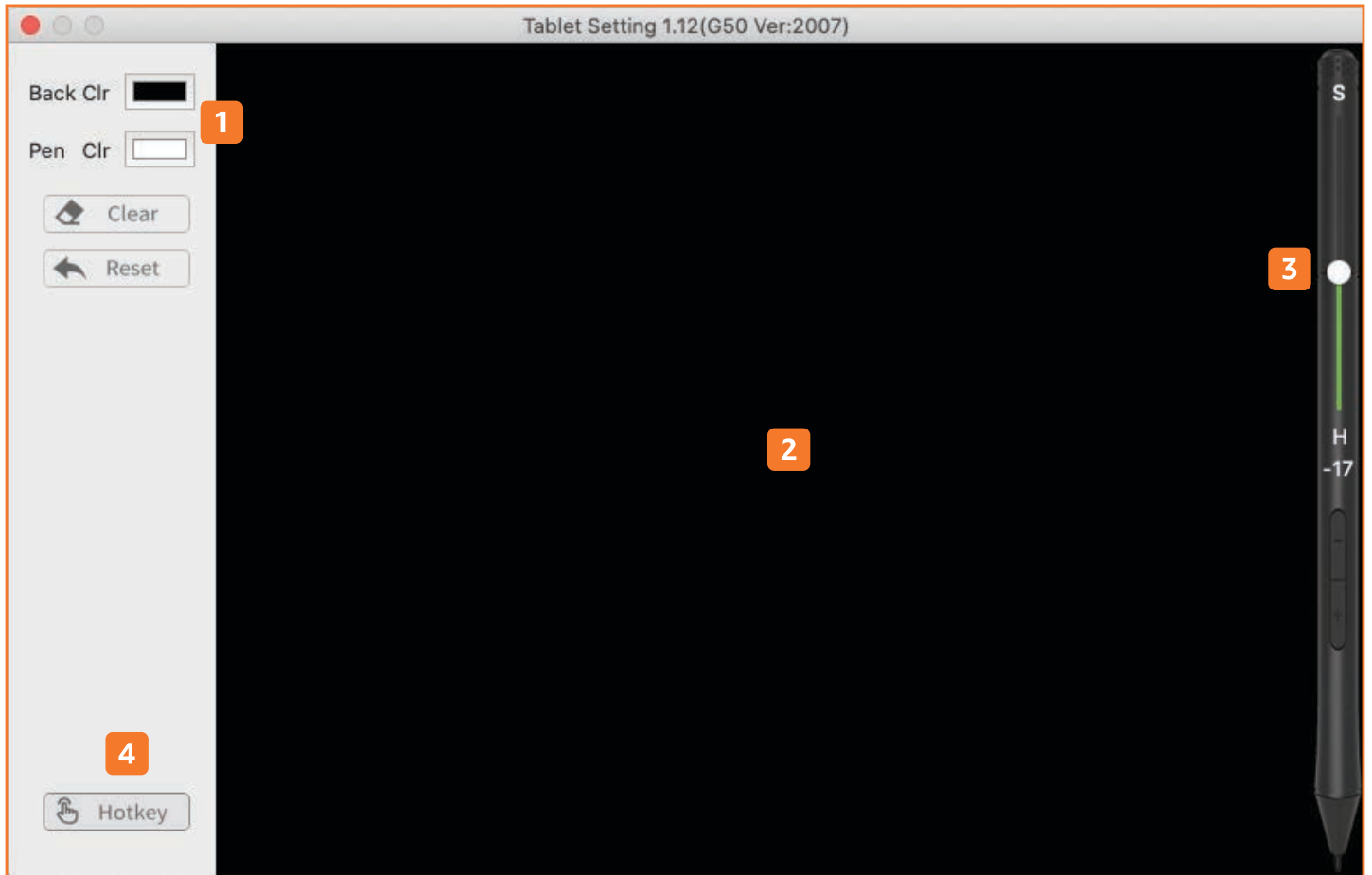

1 Set the colour of the background and pen stroke on the test paint area.

2 The test paint area for testing the customized settings.

3 Drag to fine-tune the pen pressure.

4 Click for making customized settings of the keys and buttons.

9.2.1 Hotkey

1. Select the key to customize its function (Fig. 1). The corresponding key is highlighted in grey.

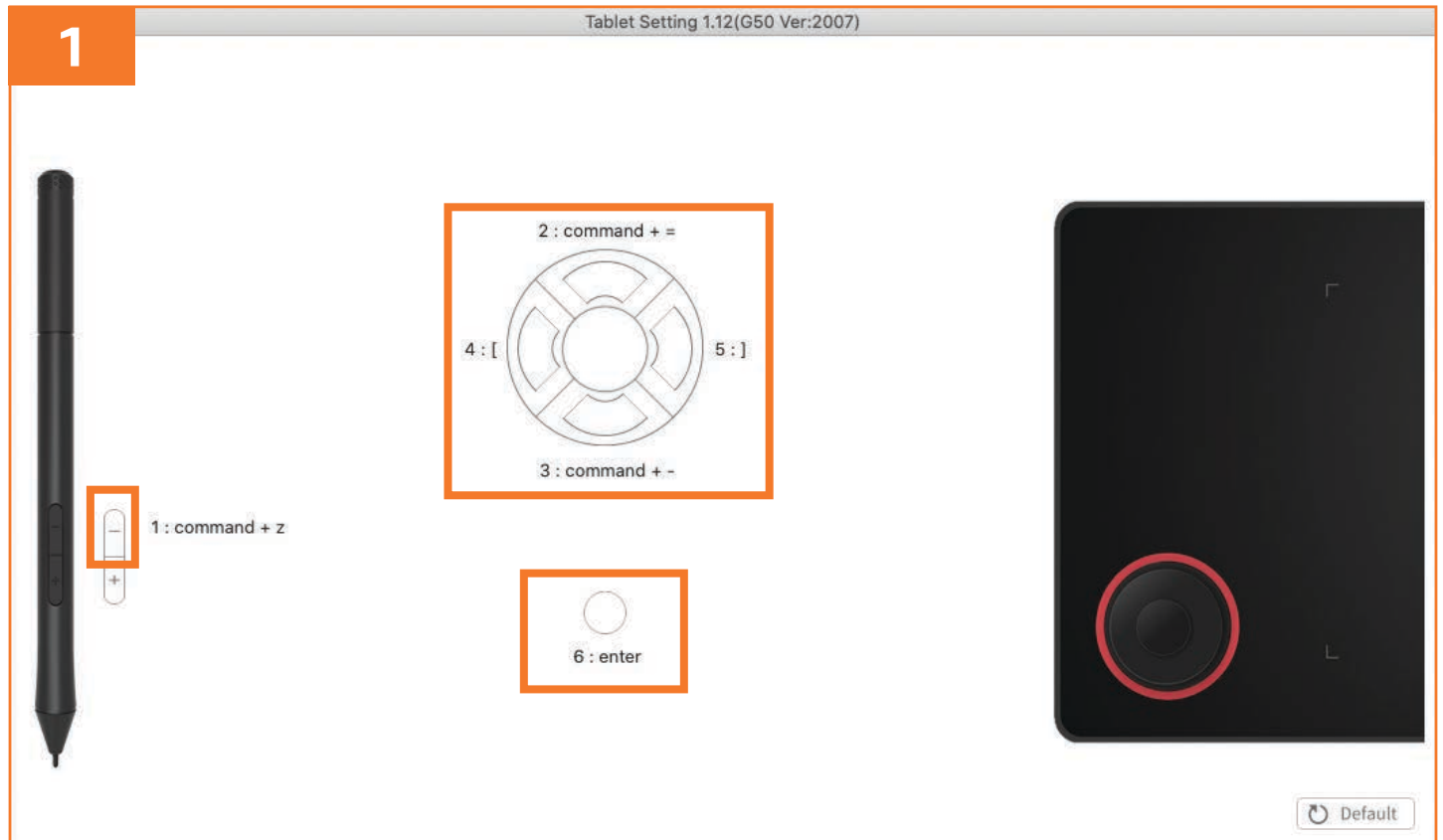

2. Set the function of the key by selecting an option from the drop-down list and checking/unchecking boxes. Click the Yes button to confirm the changes (Fig. 2).

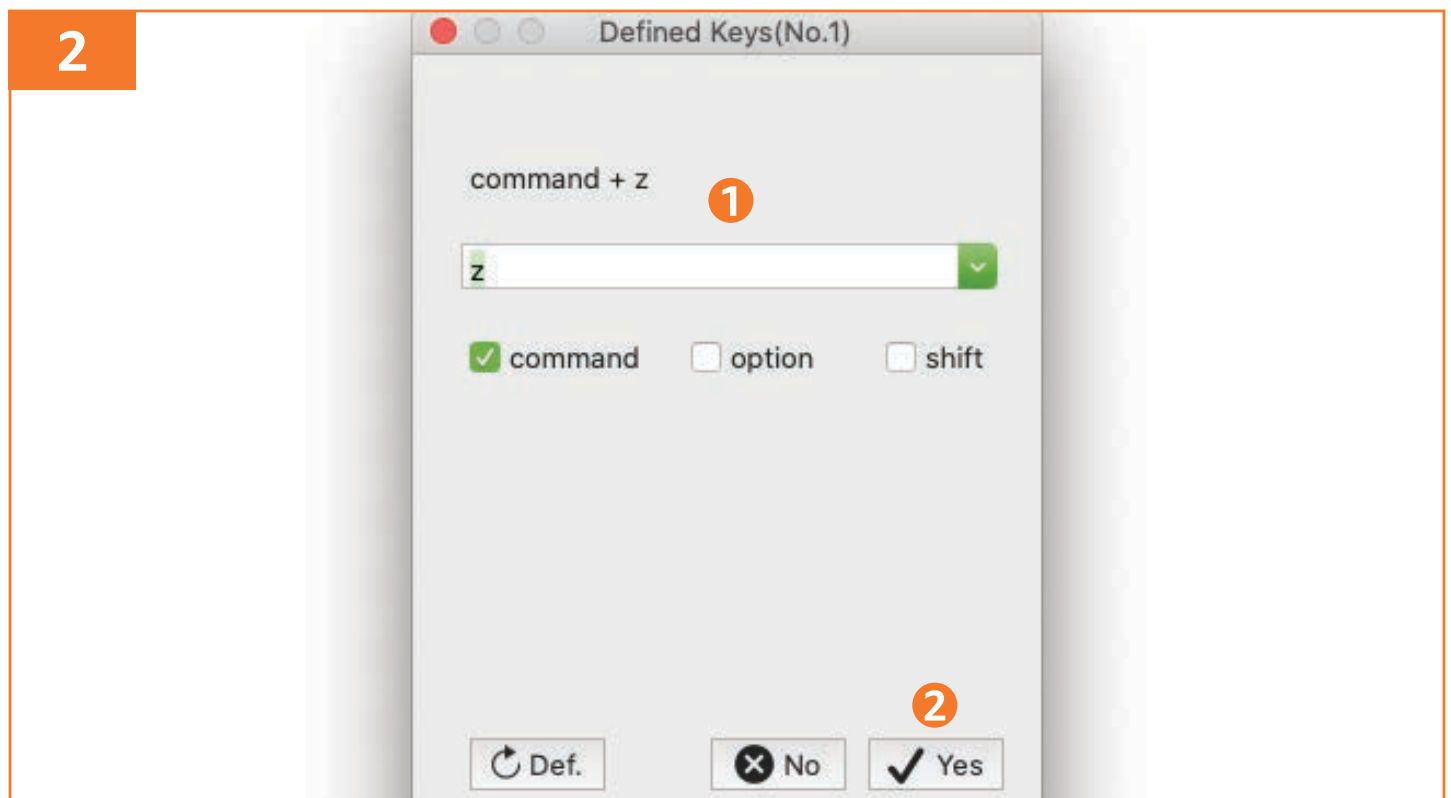

10. Cleaning and Maintenance

NOTICE

- ▶ Unplug the product before cleaning.
- ▶ During cleaning do not immerse the product in water or other liquids. Never hold the product under running water.

10.1 Cleaning

- ▶ To clean the product, wipe with a soft, slightly damp cloth.
- ▶ Wipe the product dry after cleaning.
- ▶ Never use corrosive detergents, wire brushes, abrasive scourers, metal or sharp utensils to clean the product.

10.2 Storage

Store the product in its original packaging in a dry area. Keep away from children and pets.

11. Frequently Asked Questions

11.1 Windows®

Problem	Solution
The product does not work.	<ul style="list-style-type: none"> ▶ The product is compatible only with Windows 7/8/10 or later. Download the proper operating system. ▶ Connect the product to a compatible computer. Open Pen Driver and run Tablet_SetupV4 to install the driver. ▶ For Windows 7, turn off flicks function. ▶ Pin the "Graphic Tablet" software to the taskbar. To do so, right click on the "Graphic Tablet" software, and select Pin to taskbar.

11.2 macOS®

Problem	Solution
The product does not work.	<ul style="list-style-type: none"> ▶ The product is compatible only with macOS X 10.7 or later. Download the proper operating system. ▶ Connect the product to a compatible computer. Open Pen Driver and run TabletDriver.dmg. ▶ Allow Accessibility to MyTabletDaemon: Go System Preferences > Security & Privacy > Privacy > Accessibility > check MyTabletDaemon. ▶ For macOS 10.15 or later, allow MyTabletDaemon for input monitoring and full disk access: <ul style="list-style-type: none"> – Go System Preferences > Security & Privacy > Privacy > Input Monitoring > check MyTabletDaemon. – Go System Preferences > Security & Privacy > Privacy > Full Disk Access > check MyTabletDaemon.

11.3 Android™

Problem	Solution
The product does not work.	<ul style="list-style-type: none"> ▶ Disable the auto-rotate function on the Android™ device. ▶ The product is compatible with Android™ device supports OTG only. Enable the OTG function on the Android™ device. ▶ Connect the product to the Android™ device properly. Use a USB OTG cable (not included) if needed.

11.4 Usage

Problem	Solution
The pen pressure is abnormal.	<ul style="list-style-type: none"> ▶ The pen nib wears out. Replace a new pen nib. ▶ Perform proper settings of the digital art software to allow pressure sensitivity.

12. Trademarks

- ▶ Microsoft® and Windows® are registered trademarks of Microsoft Corporation in the United States and/or other countries.
- ▶ macOS is a trademark of Apple Inc., registered in the U.S. and other countries and regions.
- ▶ Android™ is a trademark of Google LLC.
- ▶ Photoshop, Photoshop Lightroom and Illustrator are either registered trademarks or trademarks of Adobe in the United States and/or other countries.
- ▶ Clip Studio Paint and Manga Studio are trademarks and brands of Celsys Inc.
- ▶ Sketchbook® is a registered trademark of Autodesk, Inc., and/or its subsidiaries and/or affiliates in the USA and/or other countries.
- ▶ Corel Painter® is a trademark or registered trademark of Corel Corporation in Canada, the U.S., and/or elsewhere.
- ▶ openCanvas is a trademark of THE OPEN CANVAS, LLC.

13. Specifications

Model number	AB22G505001
Model version	2.0
Rated voltage	5 V  max. 0.5 A
Active area	131 x 90 mm
Resolution	5080 LPI
Pen pressure	8192 levels
Report rate	233 PPS
Reading height	7 mm
Interface type	USB Type-C/ Micro-USB option for OTG
Compatible operating systems	Windows 7/8/10 or later, Android OS 6.0 or later, macOS X 10.7 or later
Operating temperature	-5 °C to +40 °C
Storage temperature	-20 °C to +60 °C
Net weight	approx. 158 g
Dimensions (W x H x D)	approx. 226 x 9 x 135 mm

amazon basics

amazon.in/basics

V01-06/22